

DISIE = Data Analysis

2009-10

Kolkata

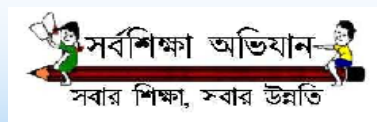
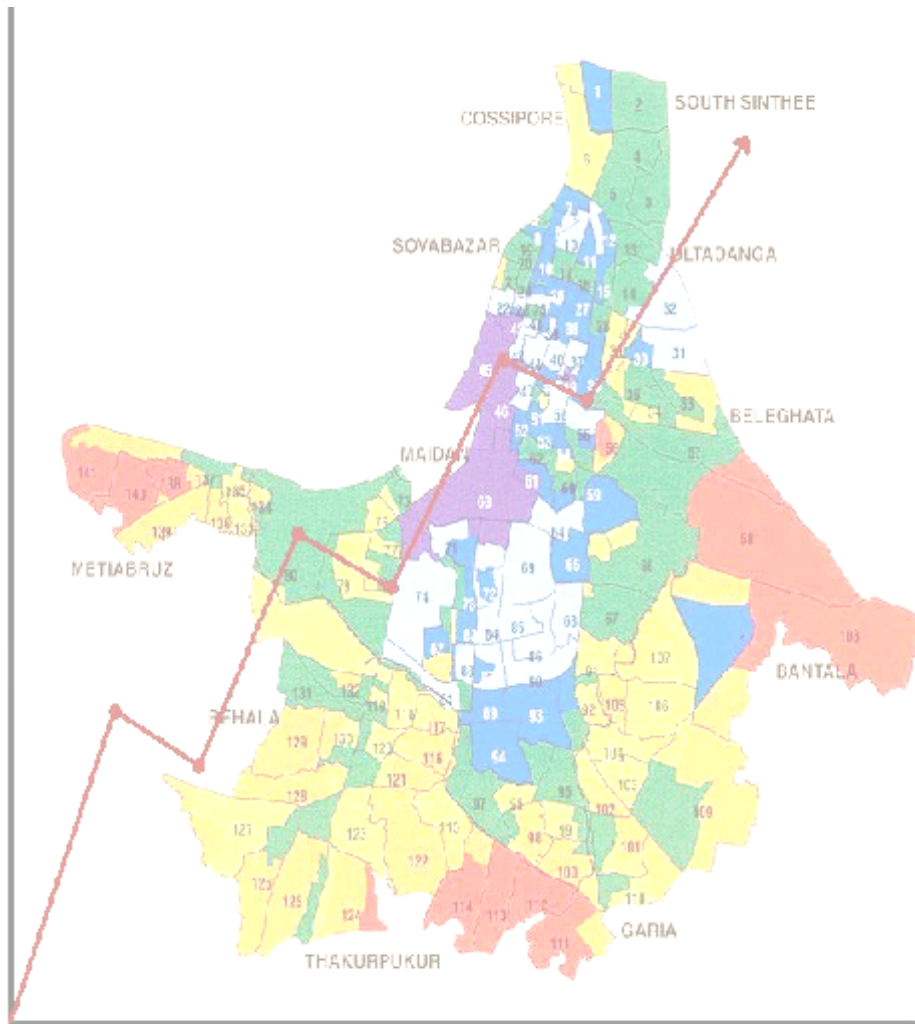

SARVA SHIKSHA MISSION, KOLKATA



**Transpiration Learning through CAL in Santoshpur Rishi Aurobindo Balika Vidyapith (H.S)
(DISE schcode: 0110710)**

District Information System for Education (DISE) – Data Analysis

Prepared By:

MIS-CELL
SSM, KOLKATA.

Under the Guidance of:

Sri. Kartik Chandra Manna, Chairman, KPSC & SSM, KOLKATA,
Smt. Sikha Roy, Dist. Project Officer SSM, KOLKATA,
Smt. Arati Mazumdar, Addl. District Project Officer, SSM, KOLKATA.

Abbreviations:

DISE: District Information System for Education
SSM: Sarva Shiksha Mission
UEE: Universal Elementary Education
SSA: Sarva Shiksha Abhiyan
MIS: Management Information System
EDI: Educational Development Index
GPI: Gender Parity Index
PTR: Pupil-Teacher Ratio
SCR: Student Classroom Ratio
MINO: Minority (Muslims only)
SPSS: Statistical Package for Social Science
CAL: Computer Aided Learning
PMIS: Project Management Information System

Acknowledgements:

Sri Alope Joarder, District Inspector of Schools (Secondary Education) Kolkata,
Smt Sikha Roy (Sen), District Inspector of Schools (Primary Education) Kolkata,
All AI/s and SI/s (Both primary and Secondary),
KMC Officials, PBSSM Officials,
And all family members of SSM Kolkata including Shiksha Bandhus.

Date: 02.09.10

Place: 'Shiksha Bhavan', 27A, Bosepukur Road (Kasba), Kolkata -700 042 (2nd Floor).

Executive Summary:

Sarva Shiksha Abhiyan(SSA), a joint project of State Govt. and Central Govt., is a programme for achieving Universal Elementary Education(UEE), has been introduced all over India. In West Bengal the name SSA has been renamed as Sarva Shiksha Mission (SSM) and which is also monitored by Dept. of School Education and Literacy, MHRD. In Kolkata SSM has been started from 2002-03 to provide equitable education of satisfactory quality to all children in the age group of 5 to 14 years. Providing elementary education to disadvantaged communities like SC, ST, Minority and Urban Deprived children is a major focus for achieving its goal of social parity.

Management Information System (MIS) plays a pivotal role in every organization by acquiring, storing and retrieving necessary and relevant information from database to place before Administrators for their necessary plans. DISE-District Information System for Education was implemented to provide district and sub-district level school data for planning, monitoring and review of various interventions.

SSA has emphasized planning with a focus on district planning as well as CRC/CIRCLE level planning with help of data analysis and sharing of data.

For the interest of Education we have decided to publish DISE- DATA ANALYSIS documentation.

We hope this documentation will help Micro Planning in this District.

*Sri. Kartik Chandra Manna, Chairman, KPSC & SSM, KOLKATA,
Smt. Sikha Roy, Dist. Project Officer SSM, KOLKATA,
&
Smt. Arati Mazumdar, Addl. District Project Officer, SSM, KOLKATA.*

Foreword:

We feel proud to convey that this year we have analyzed DISE Data for all categories, all management schools including private unaided emphasizing the context of

- EDI.
- RTE (mainly school mapping).
- Girls, SC, ST, OBC, MINORITY (“child belonging to weaker section” as per RTE).

Educational Development Index(EDI) the most effective tool for monitoring Educational planning and Administration, from which we will be able to know the present status of Education in this District, position of Sub-District level vis-à-vis other Sub-Districts(here Circle has been considered), and also we will be able to compare the Educational status of two consecutive years for Kolkata.

The main components under EDI are 1) Access 2) Infrastructure 3) Teacher and 4) Outcome. As many as 23 indicators have been analyzed with help of Database (Oracle), Application softwares (Excel and SPSS) and Statistical tools (Principal Component Analysis).

We have tried to represent it diagrammatically and also in an informative way. Some of the problem we have faced so far, which are the lack of private school information and some incomplete enumerated data.

Sarva Shiksha Mission, Kolkata is the only authority of this document and the information cannot be used for other than educational purpose without any prior permission.

Suggestions for improvement are most welcome.

MIS-In-Charge
&
PMIS-Coordinator

INDEX

	<u>Page No.</u>
Why DISE?	5
District Abstract	6-27
Kolkata District: Some Basic Information (At a glance)	6
Number of Schools	7
Enrolment	12
Teacher	18
Result	21
District Level Repeater Analysis	24
Two cases for special attention	26
Educational Development Index (EDI) for Kolkata & Circle wise Ranking	28-38
Stucture of Educational Development Index (EDI)	29
Access	30
Infrastructure	30
Teacher	31
Outcomes	31
Circle-Wise Educational Development Index (EDI)	32
Circle-Wise EDI Ranking	33
Table for Medium wise No. of Schools	35
Circle-Wise Data Analysis	39-60
Circle-Wise Data Analysis- Primary	39
Circle-Wise Data Analysis- Upper Primary	42
Caste Wise Gender Parity Index,Circle-Wise-Primary	45
Caste Wise Gender Parity Index,CircleWise-Upper Primary	48
Circle wise –Examination Result Analysis- Primary	51
Circle wise –Examination Result Analysis- Upper Primary	54
Circle wise Class wise Gender wise Repeater (I-IV)	57
Circle wise Class wise Gender wise Repeater (V-VIII)	59
KMC Borough-wise Analysis of DISE 2009-10 Data	61-71
Borough-Wise Analysis- Primary	62
Borough-Wise Analysis- Upper Primary	65
Borough-Wise Gender Parity Index (GPI) – Primary	68
Borough-Wise Gender Parity Index (GPI) – Upper Primary	70
Management Information System (MIS) - Concept	72-78
Computer Aided Learning (CAL)- Concept & Case Study from DISE	79-82
Wards under Circle at Kolkata	83
Wards under Kolkata Municipal Corporation (KMC) Borough	84
Addendum, Erratum, References, & Development Team	85

Why DISE?

Where the DISE stands?

Joint Review Mission (A few observations about DISE)

12Th JOINT REVIEW MISSION: 19-30 July 2010

- The District Information System for Education (DISE), continues to provide information about school level statistics, including school infrastructure, human resources and enrolment related details.
- The information of 1.3 million schools (both government, aided and recognized private schools) covered by DISE is currently available on online. The School Report Cards (SRC) provides school level information and is available in 6 languages, which is a tremendous effort to disseminate information about school facilities to the public.

11Th JOINT REVIEW MISSION: 15-29 January 2010

- DISE continues to be the main instrument for monitoring element, dropout, physical infrastructure, teachers, PTR, SCR and other school level indicators.
- Efforts to improve the quality of data collection continue, with a 5% independent sample check in place, and networking of 900 MIS coordinators at district and block levels to improve problem-solving.
- DISE is now in public domain (including raw data) and revised school report cards are now available for almost 1.3 million schools, a remarkable achievement (although this needs greater publicity and discussion).

School Report Cards under DISE wins

The National Award for

e-governance 2010 & eINDIA Award 2010

DISTRICT ABSTRACT

Kolkata District: Some Basic Information (At a glance)

Demographic Information (as per Census 2001)	
Total Population	4580544
Male Population	2506029
Female Population	2074515
Decadal Population Growth Rate (1991-2001)	4.1%
% of SC Population	6.45%
% of ST Population	0.49%
% of Muslim Population	20.00%
Total Literacy Rate (%)	81.31
Male Literacy Rate (%)	84.07
Female Literacy Rate (%)	77.95
Male SC Literacy Rate (%)	63.51
Female SC Literacy Rate (%)	47.25
Male ST Literacy Rate (%)	64.30
Female ST Literacy Rate (%)	42.00
Projected Population 2010-11	
Total Population	4732959
Male Population	2589146
Female Population	2143813
Administrative Set up	
Number of Educationally Backward wards	8
Number of Municipalities	1
Number of Municipal Wards	141
Educational Scenario (Primary)	
5+ to 8+ Population (as on 1.1.2010)	532260
5+ to 8+ Population girls (as on 1.1.2010)	241092
5+ to 8+ Population boys (as on 1.1.2010)	291168
5+ to 8+ Population SC girls (as on 1.1.2010)	15542
5+ to 8+ Population SC boys (as on 1.1.2010)	18789
5+ to 8+ Population ST girls (as on 1.1.2010)	1487
5+ to 8+ Population ST boys (as on 1.1.2010)	1179
Number of Educational Circles [Educational Blocks]	23
Upper Primary Educational Scenario	
9+ to 13+ Population (as on 1.1.2010)	451458
9+ to 13+ Population girls (as on 1.1.2010)	204485
9+ to 13+ Population boys (as on 1.1.2010)	246973
9+ to 13+ Population SC girls (as on 1.1.2010)	13092
9+ to 13+ Population SC boys (as on 1.1.2010)	15936
9+ to 13+ Population ST girls (as on 1.1.2010)	993
9+ to 13+ Population ST boys (as on 1.1.2010)	1219

1. Number of Schools

Management wise No. of Primary schools	
1, Department Of Education	1195
2, Tribal/ Social Welfare Department	3
3, Local body(for kolkata it is KMC and KMC run SSK)	343
4, Pvt. Aided(For kolkata it includes DA getting)	43
5, Pvt Unaided	438
6, Other	1
7, Central Govt School(K.V.S., Military schools and other schools managed by Central Govt)	7
8, Un-recognized	23
11, Unrecognized Madrasah	3
Total	2056
Technical Note: schcat in(1,2,3)	

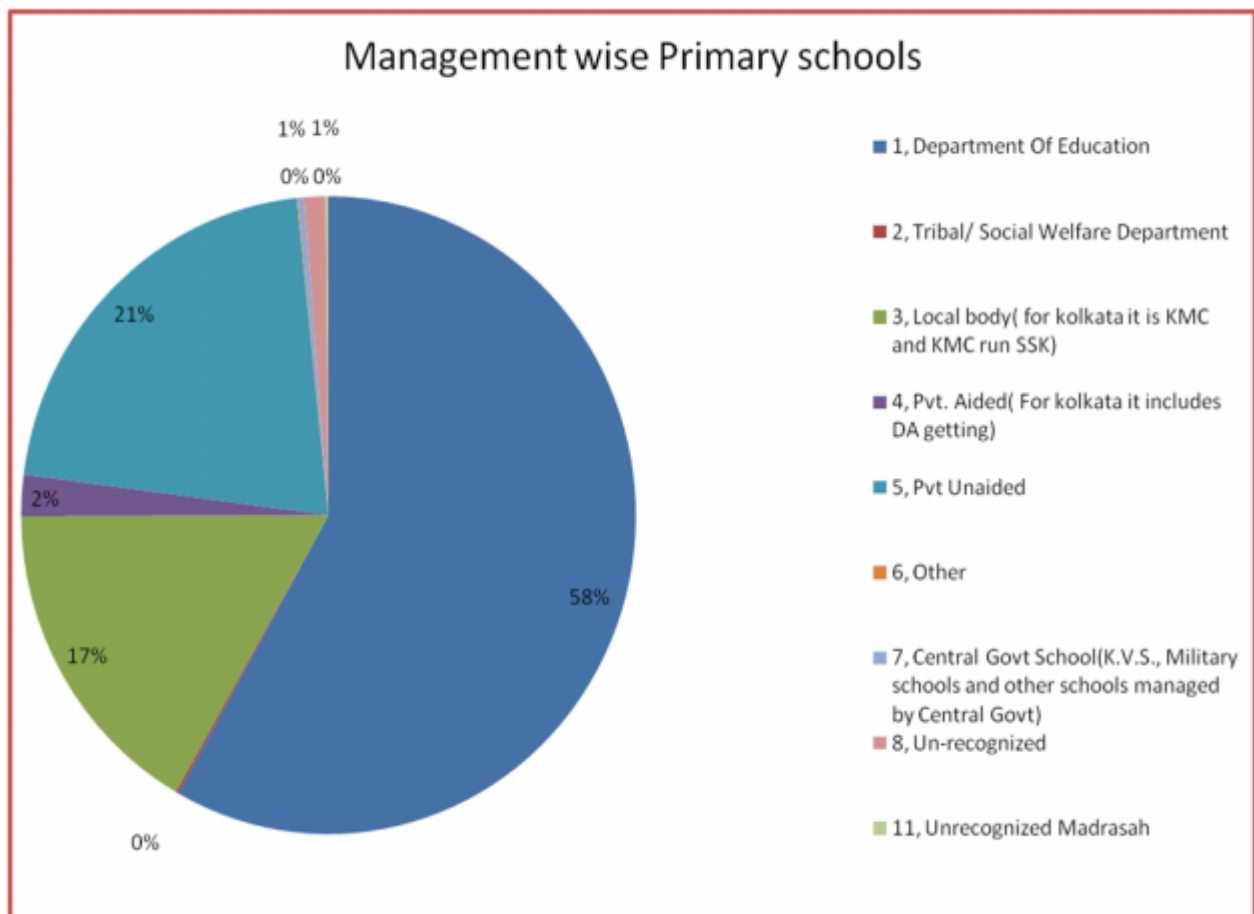

The above chart exhibits that major portion (58.13%) is KPSC School, then Private unaided is 21.30% then 16.68% is running under Local Body(Kolkata Municipal Corporation school), rest 3.9% are others(KVS,Social Welfare Dept,Un-recognized,Unrecognized Madrasah).

Management wise No. of Upper Primary schools	
1, Department Of Education	498
3, Local body(for kolkata it is KMC and KMC run SSK)	1
4, Pvt. Aided(For kolkata it includes DA getting)	78
5, Pvt Unaided	249
6, Other	1
7, Central Govt School(K.V.S., Military schools and other schools managed by Central Govt)	7
8, Un-recognized	19
10, Madrasah	9
Total	862
Technical Note: schcat in(2,3,4,5)	

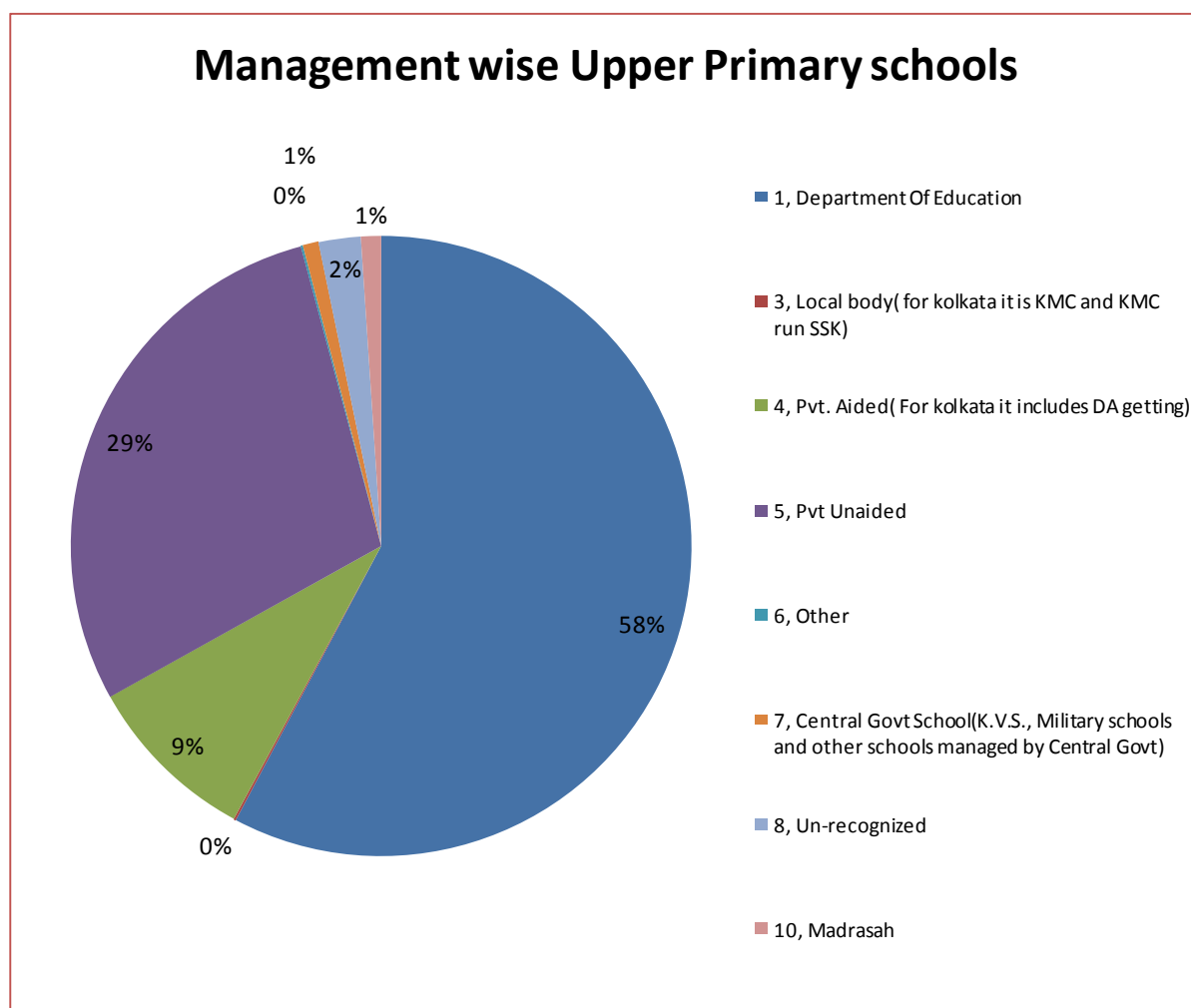

The above data reveals that maximum 57.8% of U.P schools are running under Dept. of Education formerly known as Private Aided, and 28.9% of schools are running under Private Unaided.

<i>Category Wise No Of All Management School</i>	
1, Primary	1759
2, Pry With U.P	125
3, Pry with U.P and Sec/H. Sc	172
4, Upper Primary only	60
5, Upper Primary with Sec/H.Sec	505
Total	2621

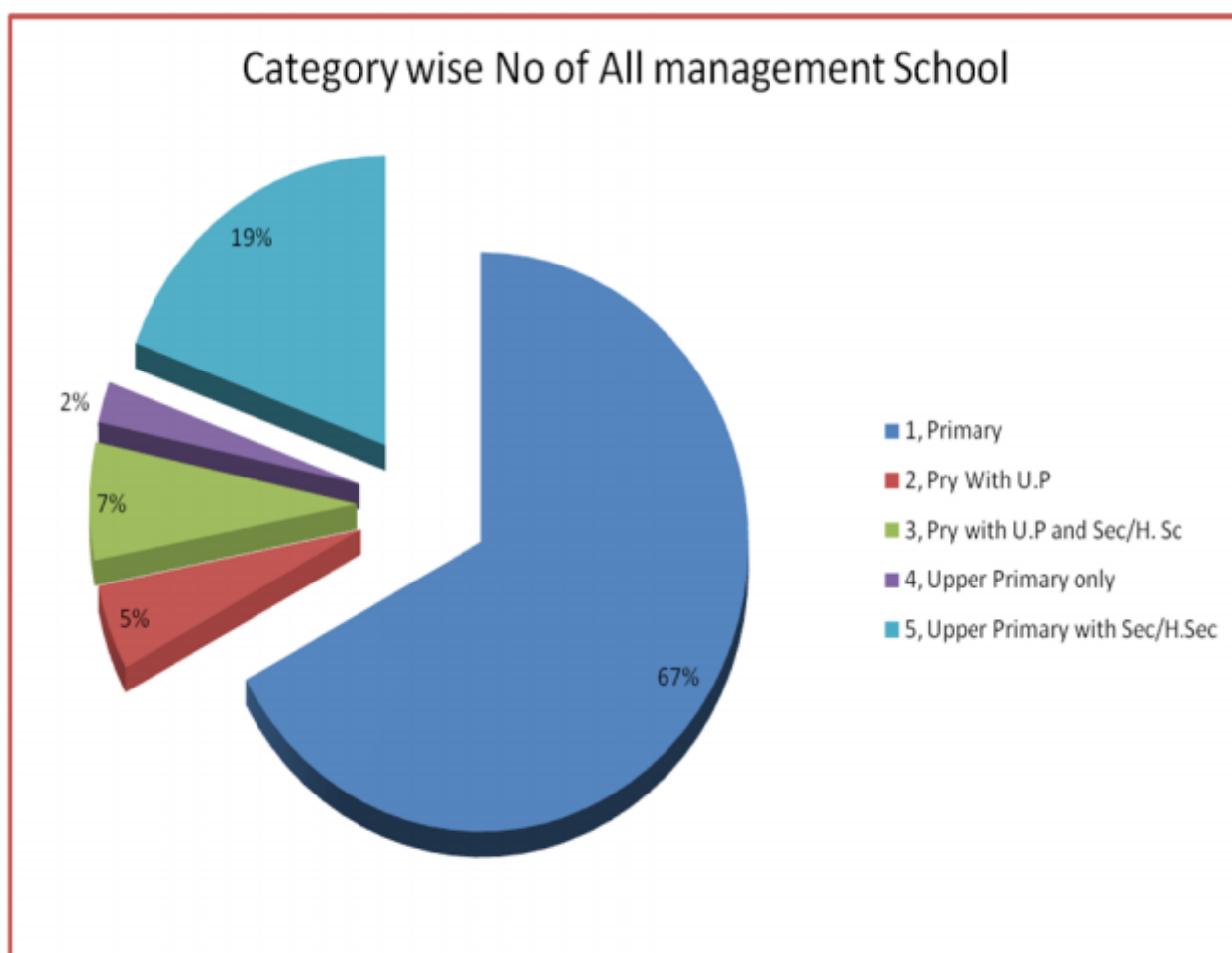

The above table and diagram, depicts that Maximum no. of schools are Primary (1759) then 19.26% are Upper Primary with Sec/H.Sec. Here we get the Primary: Upper Primary ratio of Kolkata as 2.39:1.

<i>Category Wise No Of Govt., Govt Aided School</i>	
1-Primary	1526
2- Pry With U.P	5
3-Pry with U.P and Sec/H. Sc	61
4- Upper Primary only	42
5- Upper Primary with Sec/H.Sec	486
Total	2120

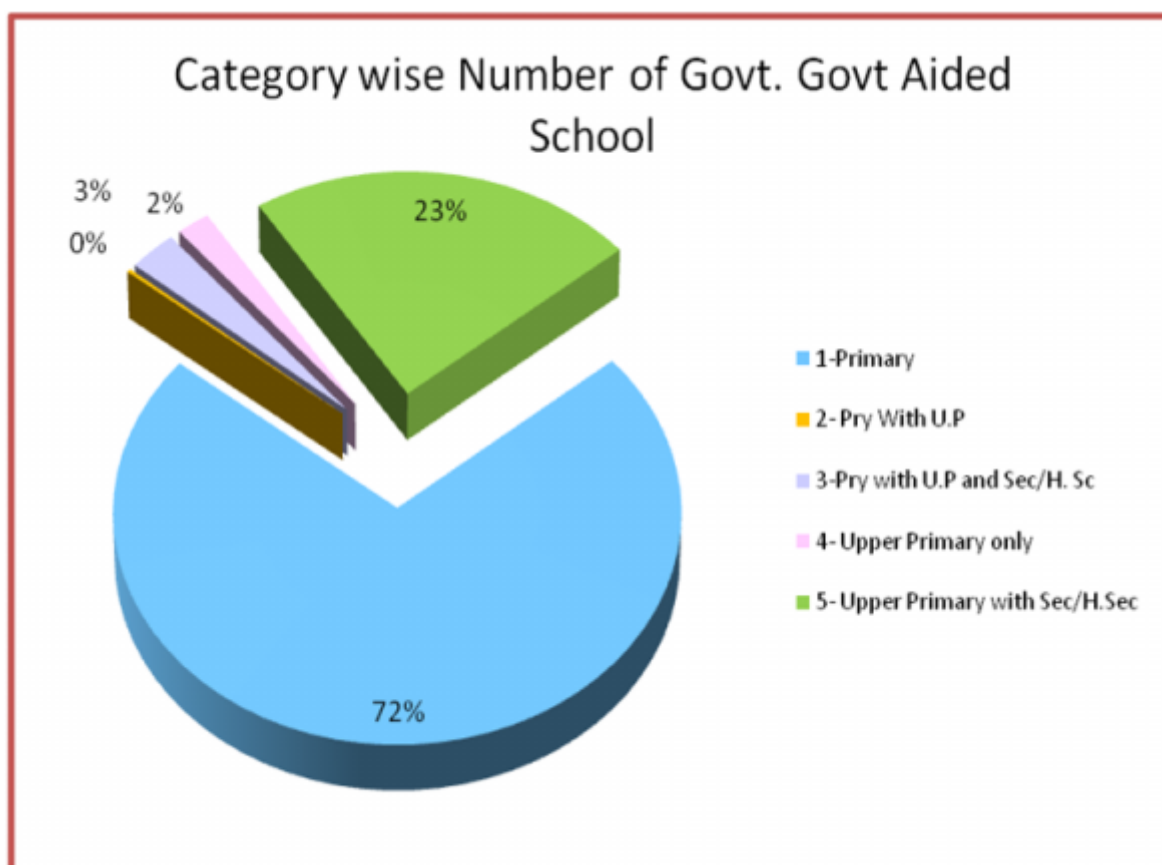

The above table and diagram, depicts that Maximum no. of schools are Primary (1526) then 22.92% are Upper Primary with Sec/H.Sec.

Category Wise No Of Private Schools	
1, Primary	233
2, Pry With U.P	120
3, Pry with U.P and Sec/H. Sc	111
4, Upper Primary only	18
5, Upper Primary with Sec/H.Sec	19
Total	501

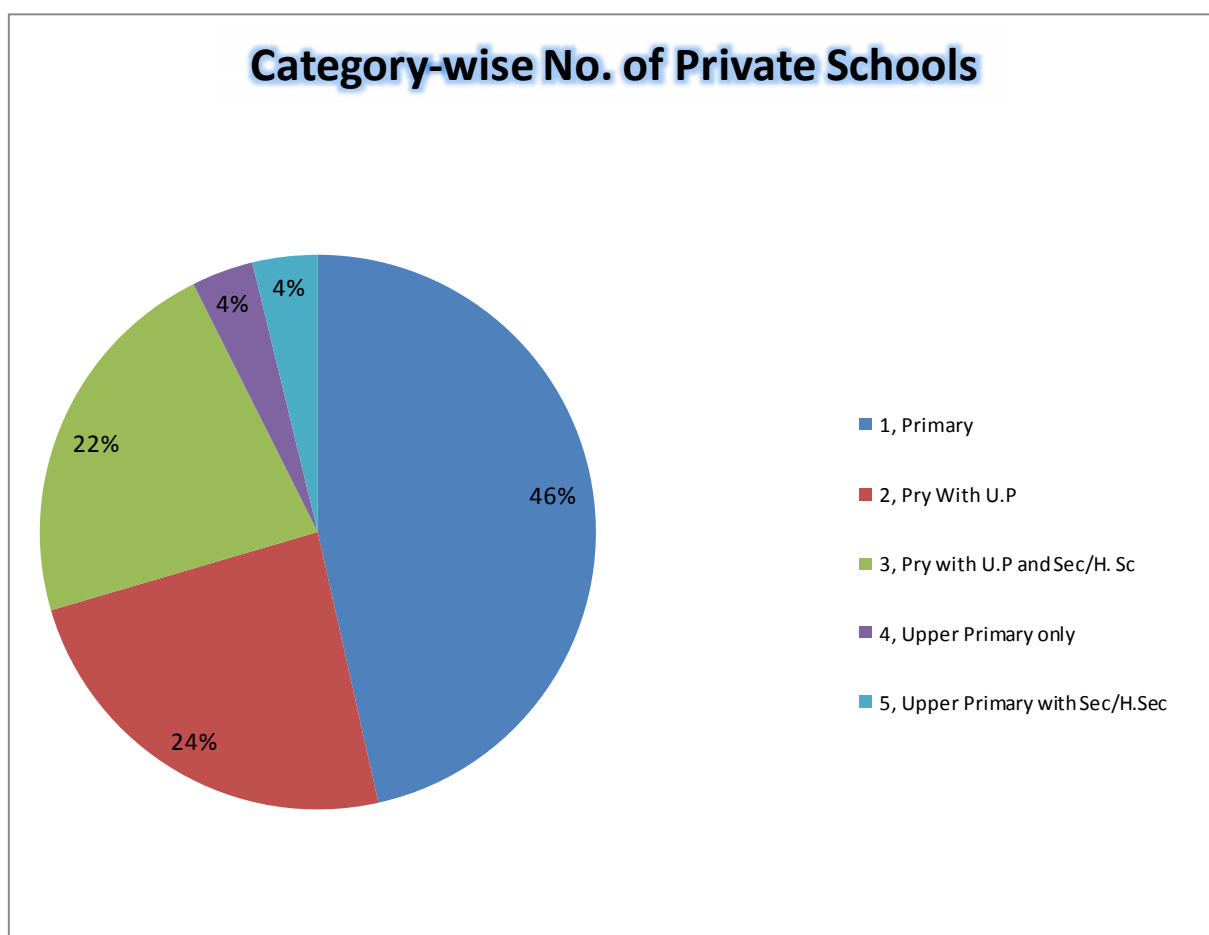

The above table depicts that 46.5% of the Private schools are Primary, and 3.59% are only Upper Primary.

2. Enrolment

Year Wise Enrolment and GPI: All Management

Year	Primary		GPI	Upper Primary		GPI
	Boys	Girls		Boys	Girls	
2002-03	109329	112749	103.13	70751	74353	105.09
2003-04	102233	105139	102.84	67544	71778	106.27
2004-05	97673	101537	103.96	73938	80744	109.21
2005-06	90831	94783	104.35	84064	87410	103.98
2006-07	111579	112393	100.73	107831	111072	103.01
2007-08	101482	102390	100.89	98780	100236	101.47
2008-09	118505	117960	99.54	105804	118037	111.56
2009-10	126039	129068	102.40	114516	124530	108.74

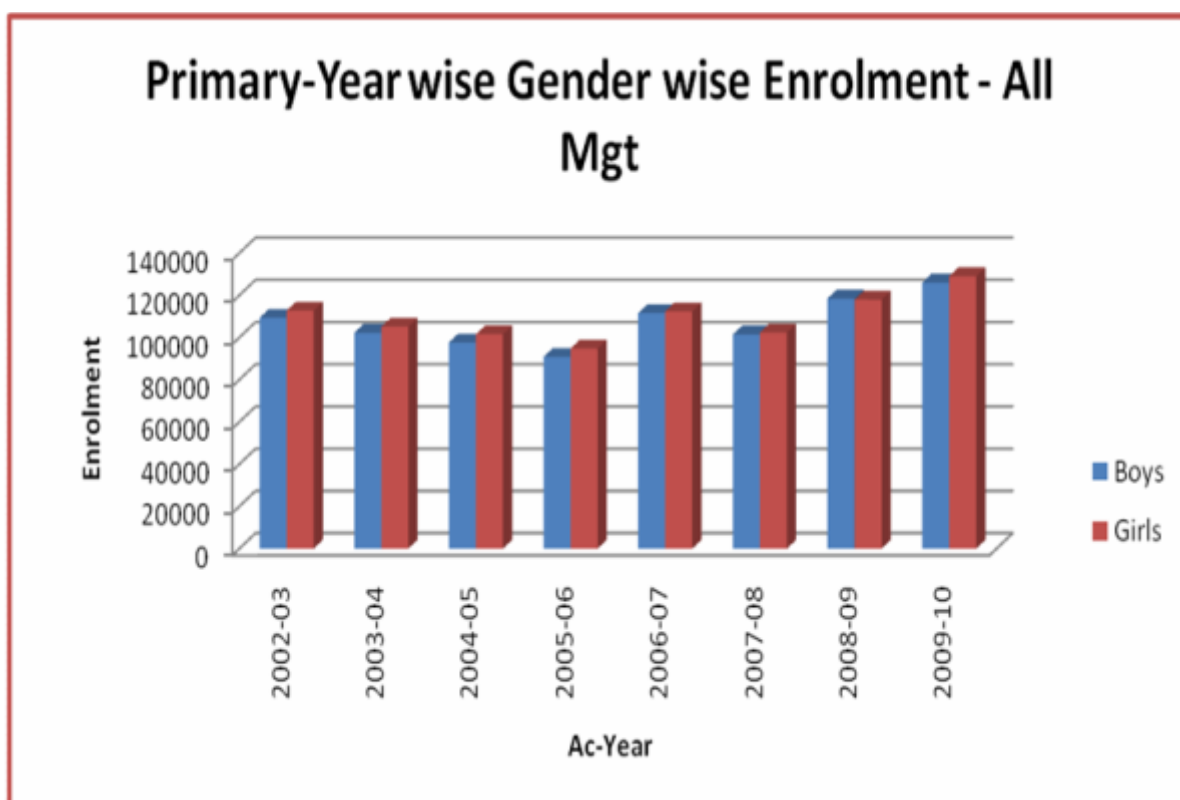

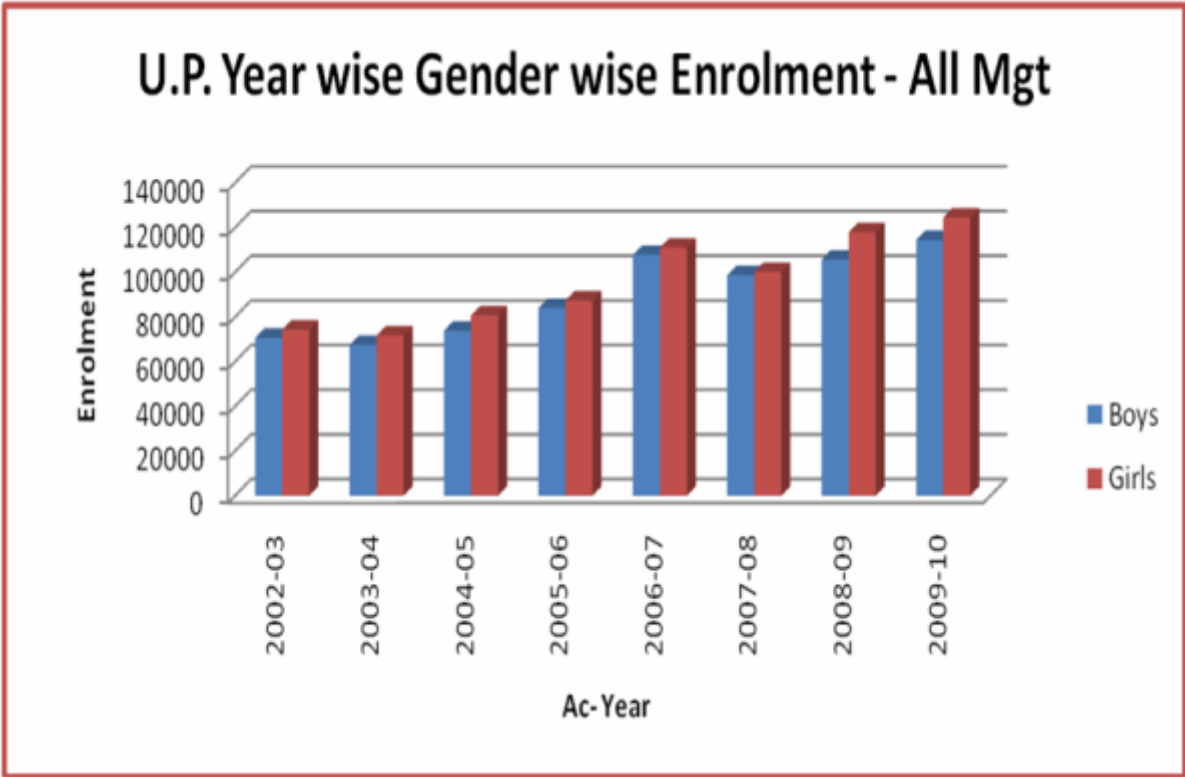

The chart for Year-wise and Gender wise enrolment is self explanatory in which it means that enrolment trend curve is slightly upward, that is, Enrolment has increased this year in both Primary and Upper Primary from that of Previous years.

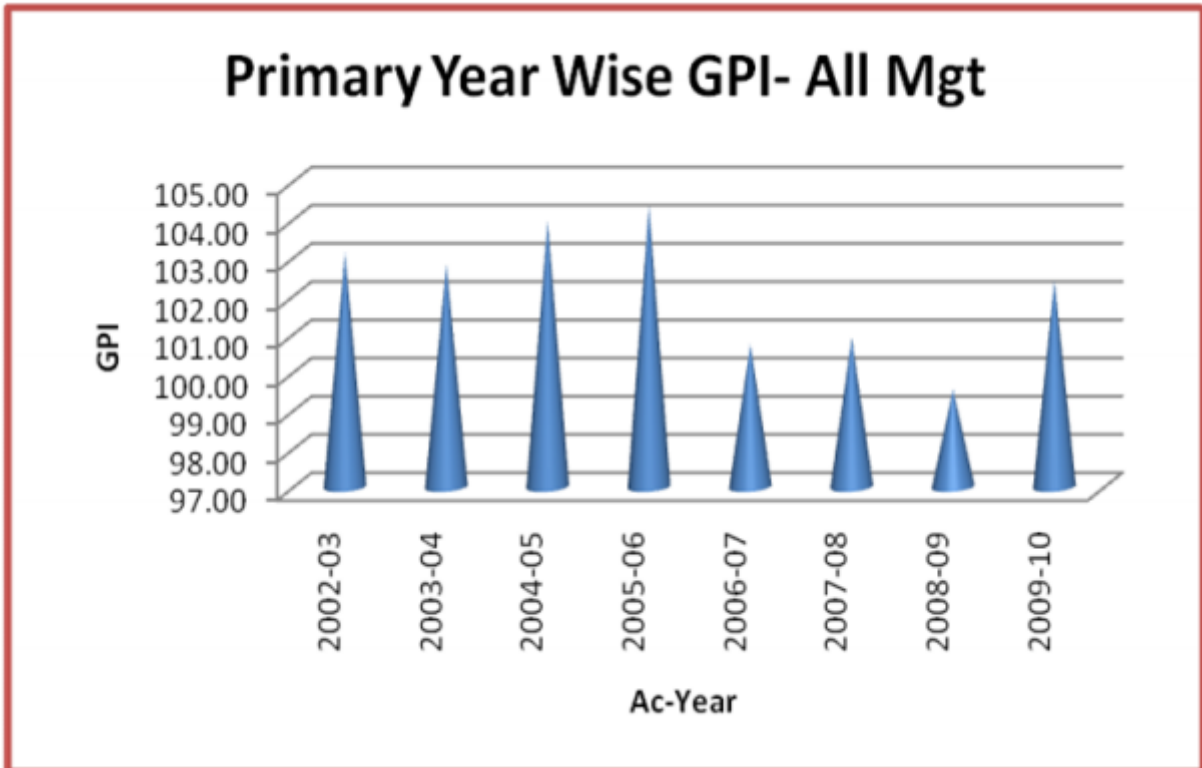

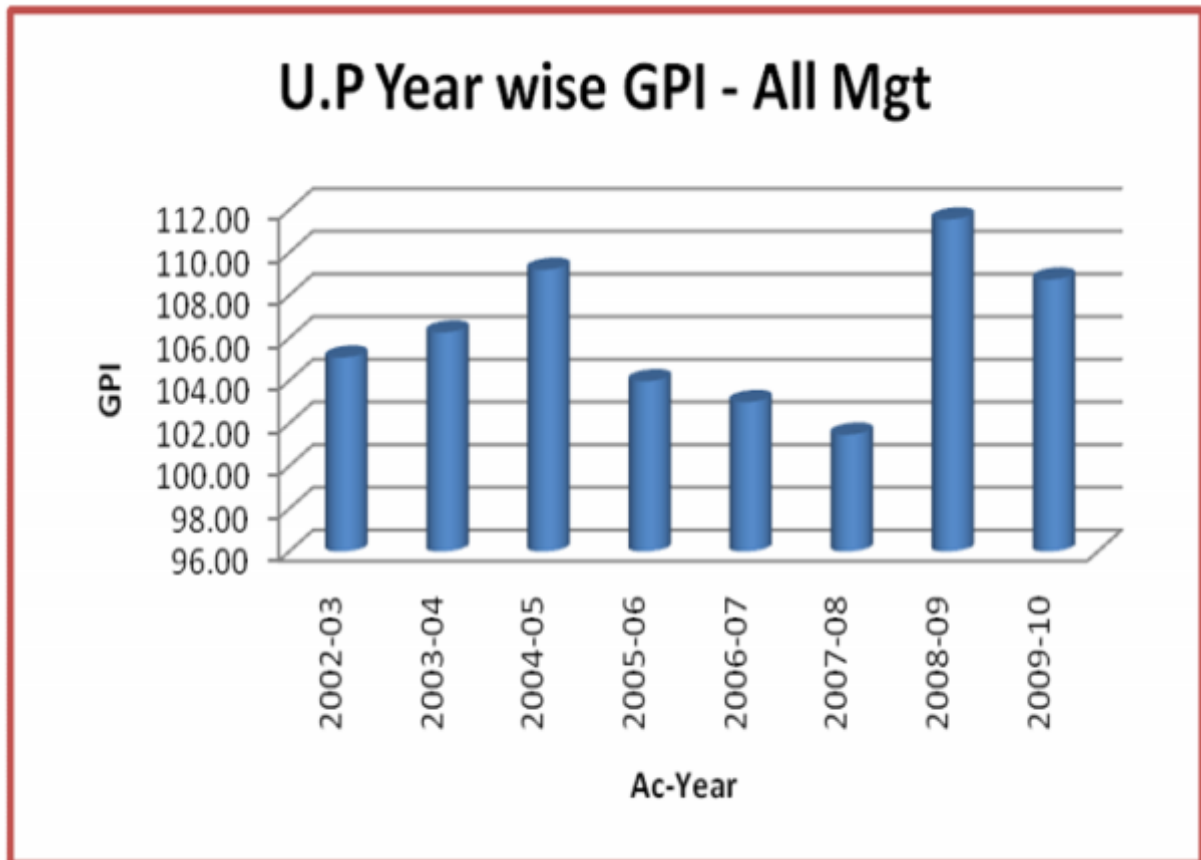

In the Gender Parity Index(GPI) graph, Primary the GPI is nearly 100 in the year 2006-07, 2008-09 which is a good result, for other years it is above 100. For this further analysis is required relating the population ratio(1000:828).

In the Gender Parity Index(GPI) graphs, Upper Primary the GPI is nearly 100 in the year 2006-07, 2007-08 which is good result, for other years it is above 100. For this further analysis is required relating to the population ratio(1000:828).

Enrolment Summary:- ALL MANAGEMENT

District: Kolkata

School category : All categories

Academic year : 2009 - 10

Enrolment		Classes								Total		
		I	II	III	IV	V	VI	VII	VIII	I - IV	V - VIII	I-VIII
General	Boys	34148	28857	29246	28764	26255	24088	23931	23163	121015	97437	218452
	Girls	34585	30011	30298	30030	29198	27321	27621	26172	124924	110312	235236
SC	Boys	1200	871	945	874	3284	3118	3133	3127	3890	12662	16552
	Girls	1009	764	776	780	2732	2724	2850	2746	3329	11052	14381
ST	Boys	110	85	94	84	147	161	160	150	373	618	991
	Girls	78	70	71	51	182	155	145	183	270	665	935
OBC	Boys	184	185	185	207	997	924	964	914	761	3799	4560
	Girls	145	126	140	134	640	580	678	603	545	2501	3046
Total	Boys	35642	29998	30470	29929	30683	28291	28188	27354	126039	114516	240555
	Girls	35817	30971	31285	30995	32752	30780	31294	29704	129068	124530	253598
	Total	71459	60969	61755	60924	63435	59071	59482	57058	255107	239046	494153

Minority	Boys	6343	5102	5070	4951	4856	4242	3847	3572	21466	16517	37983
	Girls	5663	4648	4838	4539	6060	5380	5279	4754	19688	21473	41161
	Total	12006	9750	9908	9490	10916	9622	9126	8326	41154	37990	79144

Note: - The Minority enrolment is included in the General Enrolment, that is, number of students belonging to the general category includes student belonging to the Minority Community.
Thus, Total Enrolment = General+SC+ST+OBC.

Enrolment Summary:- Govt., Govt. Aided

District: Kolkata

School category : All categories

Academic year : 2009 - 10

Enrolment		Classes								Total		
		I	II	III	IV	V	VI	VII	VIII	I - IV	V - VIII	I-VIII
General	Boys	24331	19829	20515	20294	19267	17849	18041	17443	84969	72600	157569
	Girls	25037	20647	21170	21242	21676	20134	20287	19736	88096	81833	169929
SC	Boys	1084	789	872	807	3252	3091	3094	3099	3552	12536	16088
	Girls	923	685	693	710	2681	2676	2796	2687	3011	10840	13851
ST	Boys	95	75	85	72	139	156	158	148	327	601	928
	Girls	66	55	52	39	167	138	128	166	212	599	811
OBC	Boys	124	147	130	151	970	904	939	900	552	3713	4265
	Girls	96	78	87	94	588	547	639	570	355	2344	2699
Total	Boys	25634	20840	21602	21324	23628	22000	22232	21590	89400	89450	178850
	Girls	26122	21465	22002	22085	25112	23495	23850	23159	91674	95616	187290
	Total	51756	42305	43604	43409	48740	45495	46082	44749	181074	185066	366140

Minority	Boys	5571	4472	4459	4378	4299	3700	3406	3164	18880	14569	33449
	Girls	5086	4086	4175	3993	5537	4866	4761	4296	17340	19460	36800
	Total	10657	8558	8634	8371	9836	8566	8167	7460	36220	34029	70249

Note: - The Minority enrolment is included in the General Enrolment, that is, number of students belonging to the general category includes student belonging to the Minority Community.
Thus, Total Enrolment = General+SC+ST+OBC.

Enrolment Summary: Private Unaided

District:Kolkata

School category: All categories

Academic year : 2009 - 10

Enrolment		Classes								Total		
		I	II	III	IV	V	VI	VII	VIII	I - IV	V - VIII	I-VIII
General	Boys	15669	13304	12788	12233	10570	9292	9113	9057	53994	38032	92026
	Girls	15807	13925	13431	12975	11531	10685	10997	10091	56138	43304	99442
SC	Boys	491	322	343	298	317	248	275	269	1454	1109	2563
	Girls	436	311	321	305	189	166	180	168	1373	703	2076
ST	Boys	65	46	27	39	38	38	39	37	177	152	329
	Girls	55	45	44	30	35	43	34	39	174	151	325
OBC	Boys	110	98	111	90	160	134	144	125	409	563	972
	Girls	101	99	93	82	84	73	93	73	375	323	698
Total	Boys	16335	13770	13269	12660	11085	9712	9571	9488	56034	39856	95890
	Girls	16399	14380	13889	13392	11839	10967	11304	10371	58060	44481	102541
	Total	32734	28150	27158	26052	22924	20679	20875	19859	114094	84337	198431

Minority	Boys	2142	1614	1507	1381	1127	1029	906	912	6644	3974	10618
	Girls	1708	1356	1458	1336	1444	1320	1416	1320	5858	5500	11358
	Total	3850	2970	2965	2717	2571	2349	2322	2232	12502	9474	21976

Note: - The Minority enrolment is included in the General Enrolment, that is, number of students belonging to the general category includes student belonging to the Minority Community.

Thus, Total Enrolment = General+SC+ST+OBC.

3. Teacher

TEACHER ANALYSIS									
<i>Teacher 's Information Analysis, All Management</i>									
Year	Teacher Info (Regular + Para)	Total			% of Female Teacher	Untrained			% of Total Untrained w.r.to total tch
		Male	Female	Total		Male	Female	Total	
2008-09	Primary	2305	4721	7026	67.19	1304	1987	3291	46.84
	Upper Primary	2712	3791	6503	58.30	854	1132	1986	30.54
2009-10	Primary	2508	5611	8119	69.11	1530	2721	4251	52.36
	Upper Primary	2822	4075	6897	59.08	949	1330	2279	33.04
<i>Teacher 's Information Analysis, Govt., Govt Aided Management</i>									
Year	Teacher Info (Regular + Para)	Total			% of Female Teacher	Untrained			% of Total Untrained w.r.to total tch
		Male	Female	Total		Male	Female	Total	
2008-09	Primary	2079	3382	5461	61.93	1102	928	2030	37.17
	Upper Primary	2362	2928	5290	55.35	574	568	1142	21.59
2009-10	Primary	2022	3586	5608	63.94	1091	1178	2269	40.46
	Upper Primary	2376	2939	5315	55.30	590	605	1195	22.48

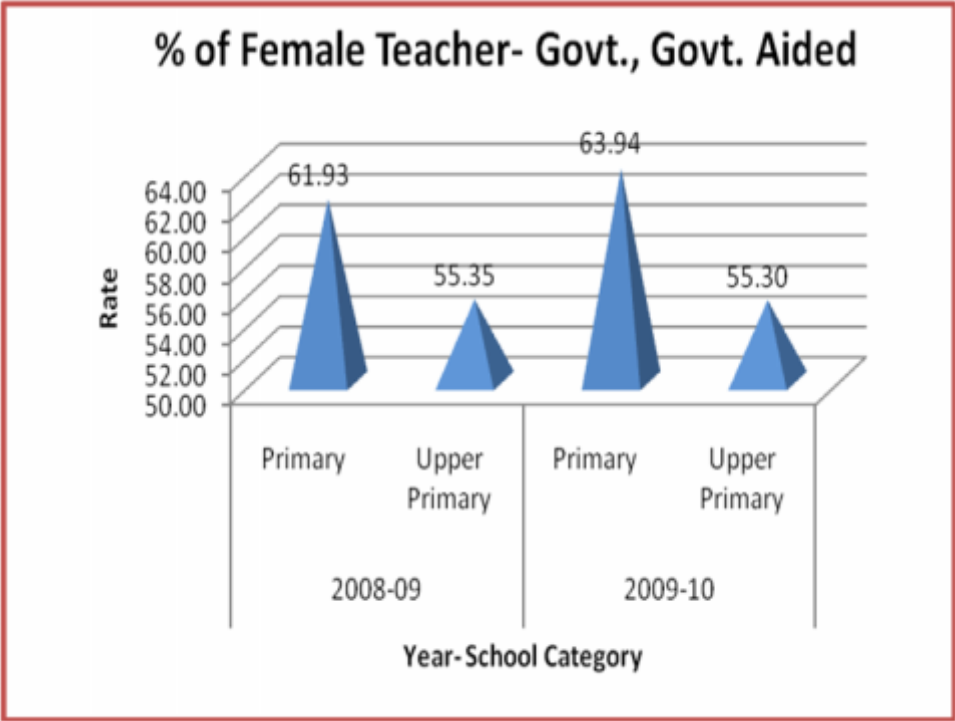
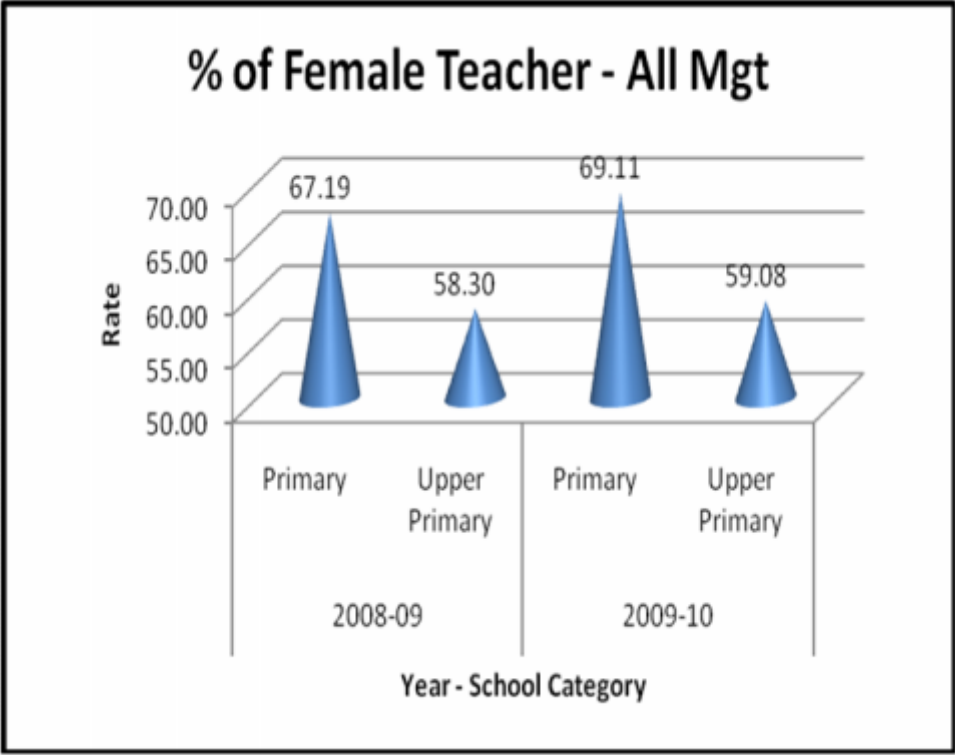

The above diagrams illustrate that number of female teachers for primary component have increased from 2008-09 to 2009-10, which is a good result from the Educational development Index's point of view. However, in Upper Primary, it has slightly decreased from that of previous year, which is not a good result.

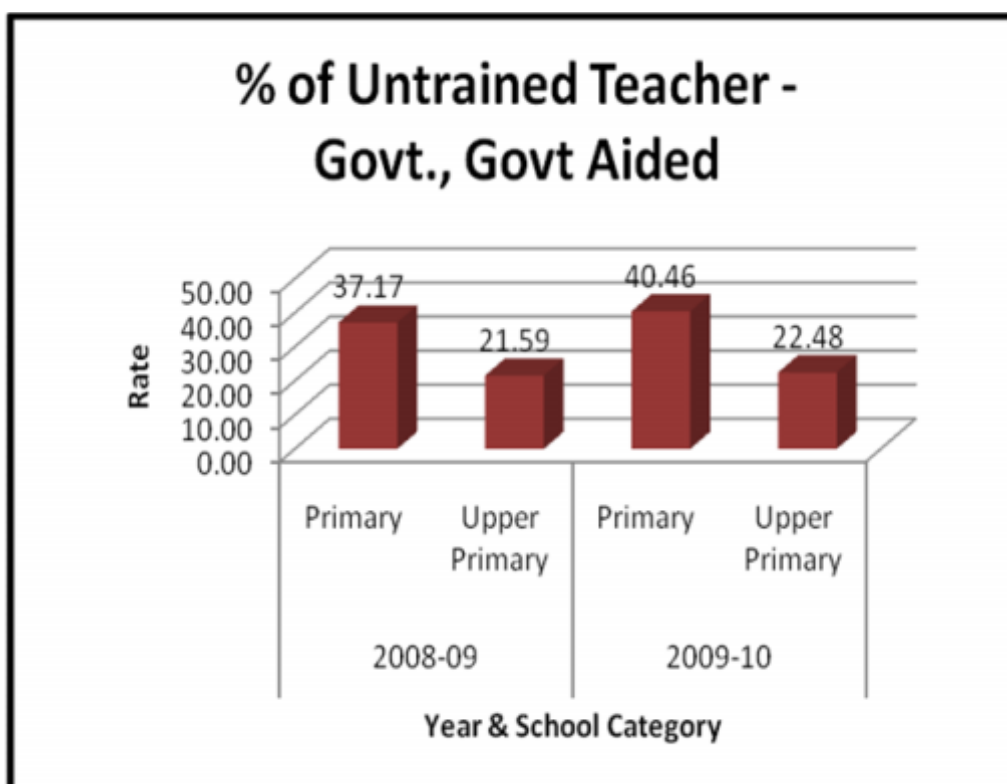
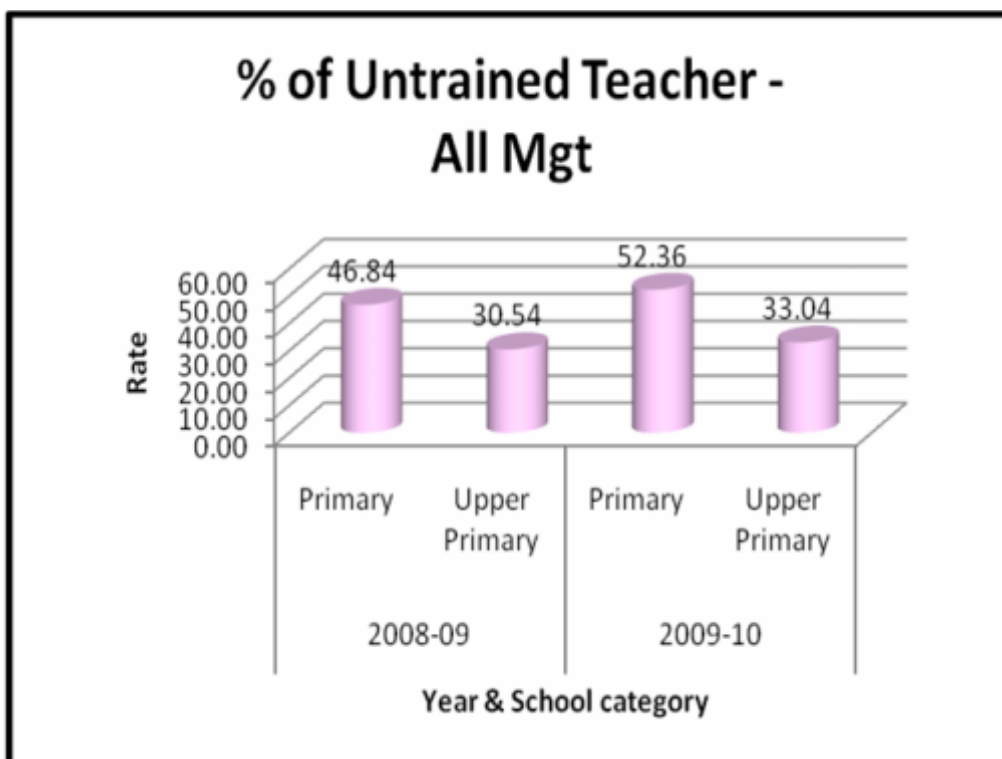

The above two diagrams illustrate that number of untrained teacher for both primary and upper primary component increased 2008-09 to 2009-10, which is not a good result from the Educational development Index's point of view.

4. Result

Examination Result Analysis- All Category, All Management

Exam Result	GENERAL		SC		ST		ALL		MINO	
	IV/V	VIII	IV/V	VIII	IV/V	VIII	IV/V	VIII	IV/V	VIII
% of Std. Passed	95.26	94.29	90.66	89.37	86.91	87.41	94.97	93.72	88.90	90.05
% of Std. who Got 60%	49.62	42.63	36.87	27.26	33.45	31.47	48.77	40.77	31.92	23.02

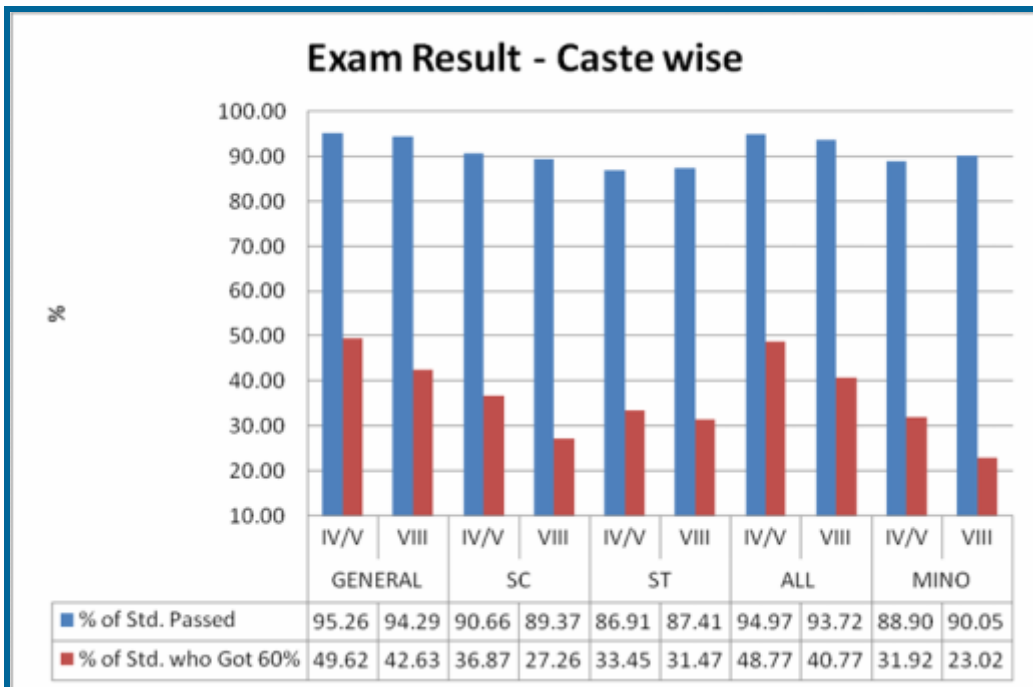
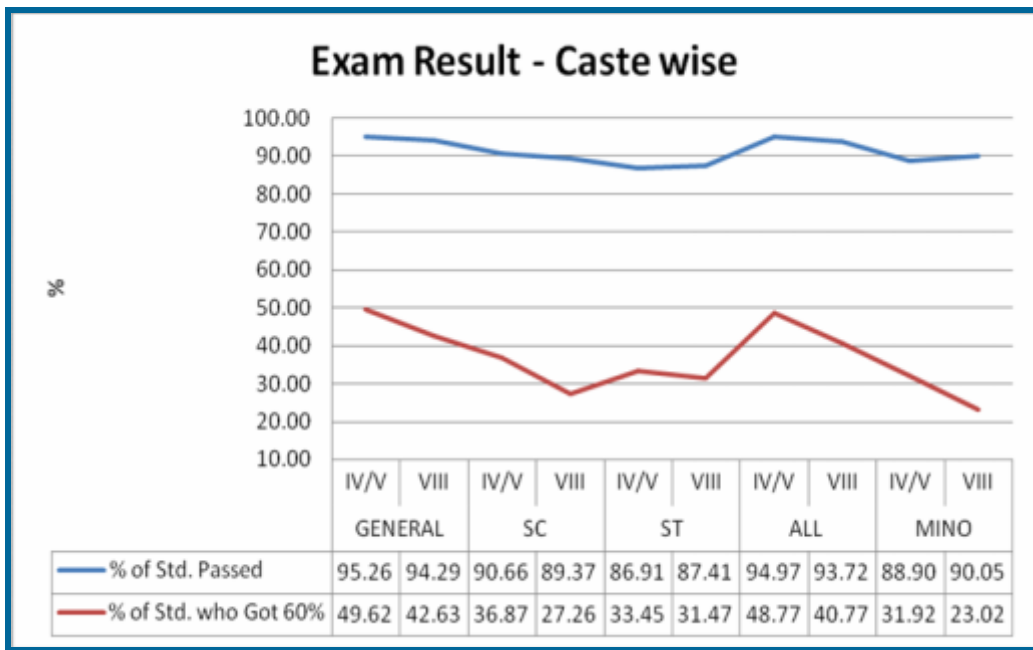

Caste-Wise Result Analysis- All Management

GENERAL	IV/V	VIII
% of Std. Passed	95.26	94.29
% of Std. who Got 60%	49.62	42.63

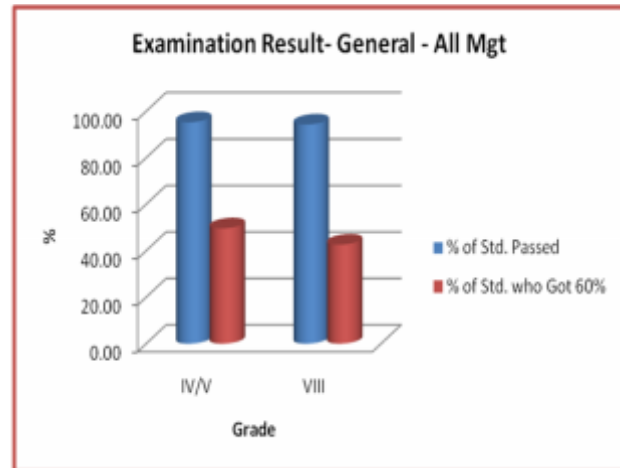

SC	IV/V	VIII
% of Std. Passed	90.66	89.37
% of Std. who Got 60%	36.87	27.26

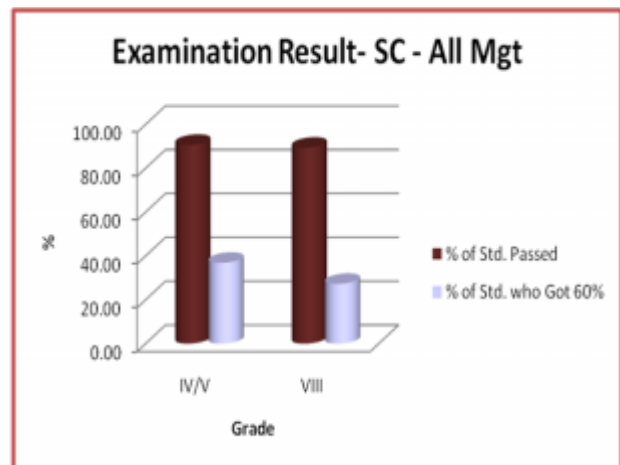

ST	IV/V	VIII
% of Std. Passed	86.91	87.41
% of Std. who Got 60%	33.45	31.47

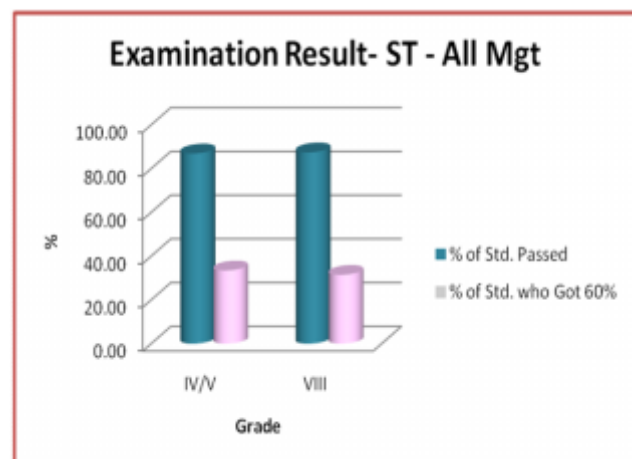

MINO	IV/V	VIII
% of Std. Passed	88.90	90.05
% of Std. who Got 60%	31.92	23.02

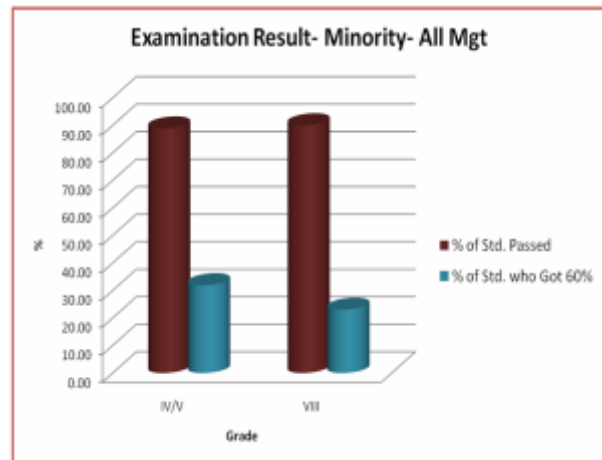

ALL	IV/V	VIII
% of Std. Passed	94.97	93.72
% of Std. who Got 60%	48.77	40.77

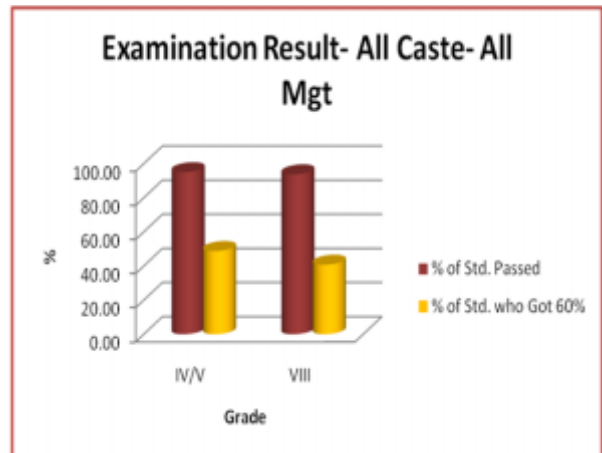

The above tables and diagrams depict a clear scenario about the Examination Result of Kolkata District. Here we see that the Exam Results of SC, ST and Minorities are almost at same level. Results of All Caste and General caste are higher than SC, ST and MINORITY. So special activities may be taken from the innovative interventions to equalize the situation.

5. District Level Repeater Analysis

Repeater Analysis: All management Schools

District kolkata

School category : All categories

Academic year : 2009 - 10

Repeater		Classes								Total		
		I	II	III	IV	V	VI	VII	VIII	I - IV	V - VIII	I - VIII
General	Boys	2613	1394	1321	1320	1334	834	854	871	6648	3893	10541
	Girls	2259	1160	1159	1207	1587	835	1113	977	5785	4512	10297
SC	Boys	133	67	47	39	219	226	260	258	286	963	1249
	Girls	118	57	69	47	237	197	243	214	291	891	1182
ST	Boys	11	2	2	3	7	13	22	10	18	52	70
	Girls	5	3	3	2	5	6	20	17	13	48	61
OBC	Boys	9	8	14	8	87	67	70	89	39	313	352
	Girls	9	6	9	11	36	44	53	62	35	195	230
Total	Boys	2766	1471	1384	1370	1647	1140	1206	1228	6991	5221	12212
	Girls	2391	1226	1240	1267	1865	1082	1429	1270	6124	5646	11770
	Total	5157	2697	2624	2637	3512	2222	2635	2498	13115	10867	23982

Minority	Boys	545	289	284	254	331	211	177	132	1372	851	2223
	Girls	441	208	260	237	580	227	250	207	1146	1264	2410
	Total	986	497	544	491	911	438	427	339	2518	2115	4633

Note: - The Minority repeater is included in the General repeater, that is, number of students belonging to the general category includes student belonging to the Minority Community.
Thus, Total = General+SC+ST+OBC.

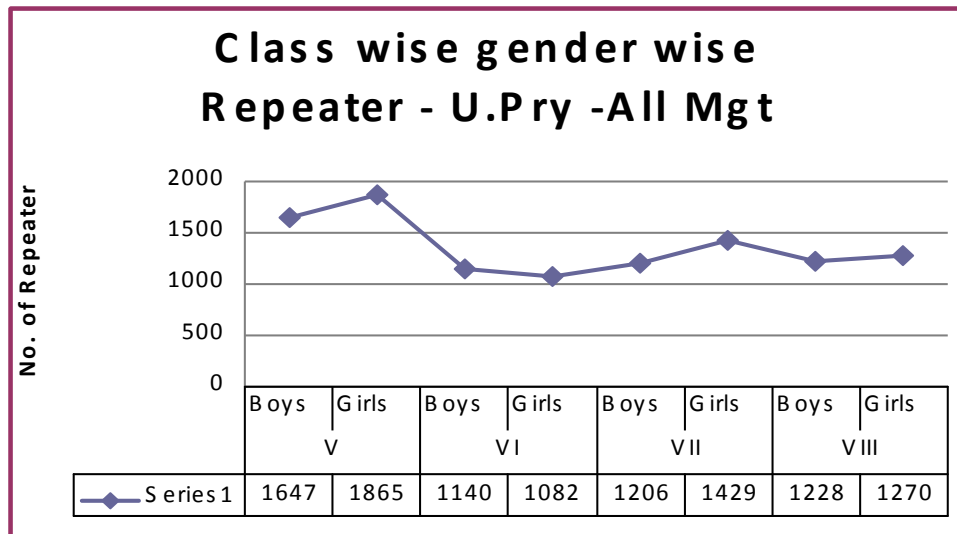
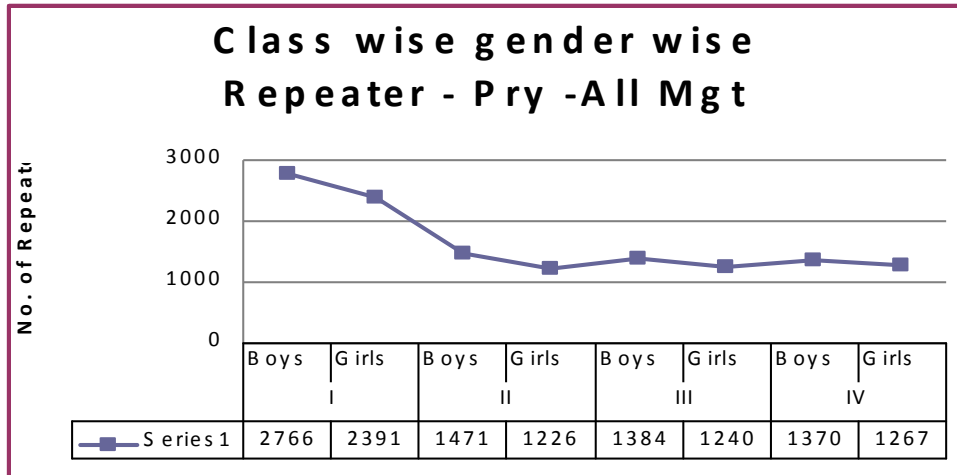

From the Chart of Class wise and gender wise Repeater, Primary we can see that Boys repeater is higher than Girls repeater.

From the Chart of Class-wise and Gender-wise Repeater, Upper Primary we get that,
 In Class V -Girls repeater is higher than boys repeater,
 In Class VI - Boys repeater is higher than girls repeater,
 In Class VII -Girls repeater is higher than boys repeater,
 In Class VIII -Girls repeater is higher than boys repeater,
 Over all girls repeater is high, which is a bad result in context with EDI as well as innovative point of view.

Two Cases for Special Attention

First Case

Percentage of Schools having Enrolment <= 50 :- All Management		
Year	Category	Percentage
2008-09	Primary	30.45
	Upper Primary	11.46
2009-10	Primary	34.33
	Upper Primary	7.89

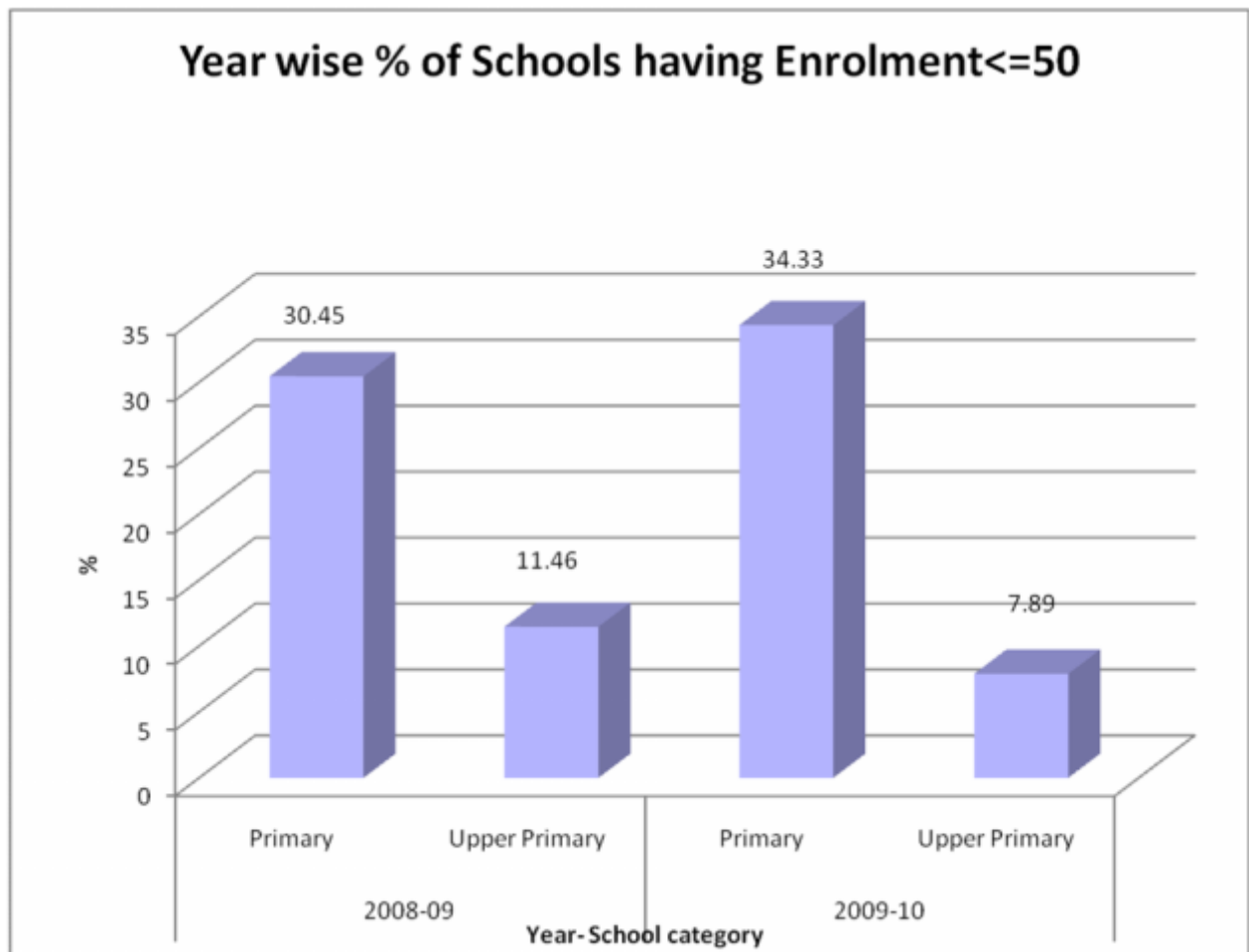

In the above graph showing percentage of schools having enrolment <=50, it shows that in primary the percentage increased from 30.45% to 34.33% in the year 2008-09 to 2009-10, which is a matter of deep concern. In Upper Primary, it decreased from 11.46% to 7.89% in the year 2008-09 to 2009-10, which recovers the situation, but special interventions may be taken to recover 100%.

Second Case

Year wise Status of Ramps, All Management				
Year	Category	Total Schools	Schools Having Ramps	% of schools having Ramps
2008-09	Primary	1639	154	9.40
	Upper Primary	829	113	13.63
2009-10	Primary	2056	164	7.98
	Upper Primary	862	134	15.55

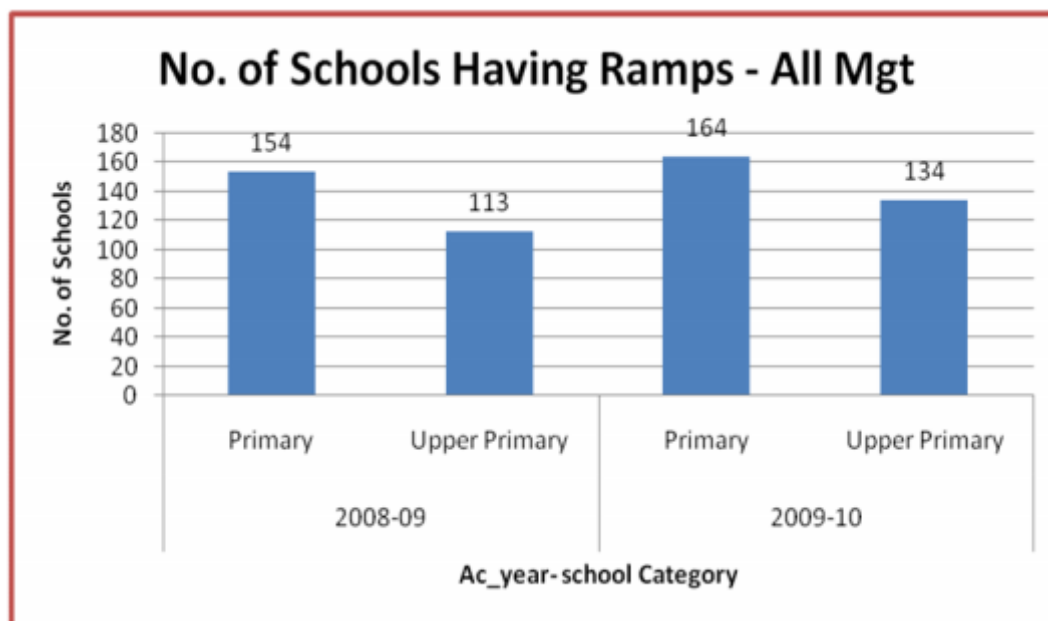

From the above table and diagram, we know that number of schools having ramps have increased in both Primary and Upper Primary during this year from that of the previous year.

Educational Development Index
(EDI) for
KOLKATA
&
Circle wise Ranking

Structure of Educational Development Index (EDI)

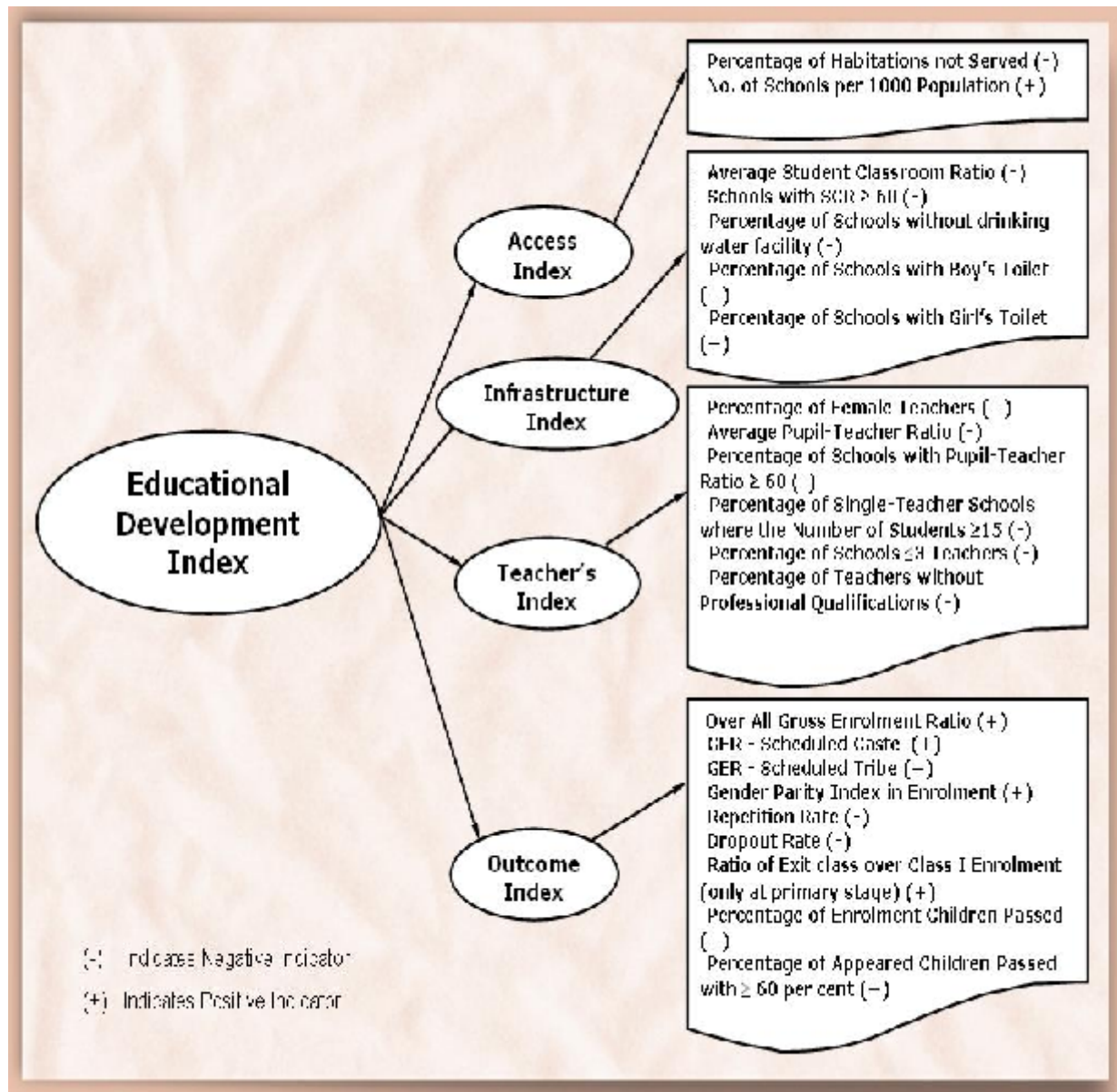

i) Access :-

STAGE	No. of Ward not served of School	% of Ward not served of School	No. of Schools per 1000 population
PRIMARY	0	0	0.43
UPPER PRIMARY	1 (Ward-9) But U.P. schools are available within Five K.M.	0.71	0.18

ii) Infrastructure :-

STAGE	No of School	Average SCR	% of Schools with SCR>60	% of schools without drinking water facilities	% of school with Common toilet	% of school with Boy's toilets	% of Schools with Girl's toilet	% of building less school
PRIMARY	2056	33.27	4.52	2.5	82.5	5.98	41.93	0
UPPER PRIMARY	862	22.94	8.82	0	99.3	31.2	83.3	0

iii) Teacher :-

STAGE	% of Female Teachers	Average PTR	% of school with PTR >60	% Single Teacher Schools Where the no of student >15	% of school with 3 or less Teachers	% of teachers without professional Qualification
PRIMARY	69.11	31.43	3.65	5.3	1021	52.36
UPPER PRIMARY	59.08	37.00	15.2	0.34	66	33.04

iv) Outcomes :-

STAGE	Overall GER	SC: GER	ST: GER	Gender Parity Index	Repetition Rate	Drop out Rate	Ratio exit class over class 1 Enrolment	% of passed children to number appeared
PRIMARY	48	1:35	1:10	102	14.46	3.35	0.85	94.97
UPPER PRIMARY	53	1:400	1:186	108	13.25	4.65	0.95	93.73

CIRCLE-WISE EDUCATIONAL DEVELOPMENT INDEX (EDI)

All Mgt, All category Composite EDI of some selected parameter

CIRCLE	TOTAL NO. OF SCHOOLS	NO. OF SCHOOLS HAVING GIRLS TOILET	% OF SCHOOLS HAVING GIRLS TOILET		AVERAGE PTR		AVERAGE SCR		NO.OF SCHOOLS HAVING PTR>60	% OF SCHOOLS HAVING PTR>60		% PASSED w.r.to NUMBER APPEARED	
			OBSERVED	NORMALIZED	OBSERVED	NORMALIZED	OBSERVED	NORMALIZED		OBSERVED	NORMALIZED	OBSERVED	NORMALIZED
CIRCLE-1	109	70	64.22	0.69	28.68	0.728	24.52	0.855	7	6.42	0.67	95.86	0.767
CIRCLE-2	93	38	40.86	0.03	30.74	0.622	31.69	0.494	2	2.15	1.00	90.78	0.000
CIRCLE-3	68	44	64.71	0.70	23.39	1.000	21.13	1.026	2	2.94	0.94	92.1	0.199
CIRCLE-4	63	25	39.68	0.00	32.69	0.522	23.08	0.927	4	6.35	0.67	94.98	0.634
CIRCLE-5	83	36	43.37	0.10	30.16	0.652	22.71	0.946	5	6.02	0.70	96.79	0.908
CIRCLE-6	86	58	67.44	0.78	32.56	0.528	24.31	0.866	11	12.79	0.17	92.57	0.270
CIRCLE-7	132	85	64.39	0.69	29.45	0.688	26.22	0.769	11	8.33	0.52	93.95	0.479
CIRCLE-8	145	72	49.66	0.28	33.45	0.483	24.67	0.847	15	10.34	0.36	96.33	0.838
CIRCLE-9	167	114	68.26	0.80	39.77	0.157	36.32	0.261	25	14.97	0.00	94.98	0.634
CIRCLE-10	154	114	74.03	0.96	34.02	0.453	30.61	0.548	14	9.09	0.46	95.25	0.675
CIRCLE-11	138	89	64.49	0.70	33.18	0.496	25.03	0.829	19	13.77	0.09	94.39	0.545
CIRCLE-12	111	65	58.56	0.53	24.59	0.938	23.55	0.904	4	3.60	0.89	96.2	0.819
CIRCLE-13	63	39	61.90	0.62	28.32	0.746	23	0.932	3	4.76	0.80	94.71	0.594
CIRCLE-14	83	45	54.22	0.41	24.65	0.935	21.64	1.000	2	2.41	0.98	95.37	0.693
CIRCLE-15	79	39	49.37	0.27	32.57	0.528	26.62	0.749	6	7.59	0.58	93.27	0.376
CIRCLE-16	121	70	57.85	0.51	31.96	0.559	36.39	0.257	8	6.61	0.65	92.18	0.211
CIRCLE-17	108	68	62.96	0.65	27.78	0.774	26.58	0.751	5	4.63	0.81	94.24	0.523
CIRCLE-18	93	52	55.91	0.46	34.39	0.434	25.5	0.806	9	9.68	0.41	97.4	1.000
CIRCLE-19	73	55	75.34	1.00	28.8	0.722	22.57	0.953	7	9.59	0.42	95.31	0.684
CIRCLE-ALIPORE	181	111	61.33	0.61	42.83	0.000	41.5	0.000	24	13.26	0.13	93.22	0.369
CIRCLE-BEHALA	142	94	66.20	0.74	29.95	0.663	25.13	0.824	8	5.63	0.73	93.34	0.387
CIRCLE-BEHALA WEST	162	106	65.43	0.72	25.69	0.882	24.33	0.865	7	4.32	0.83	95.7	0.743
CIRCLE-TOLLYGUNGE	167	91	54.49	0.42	28.87	0.718	32.01	0.478	8	4.79	0.79	93.97	0.482

CIRCLE-WISE EDI RANKING							
CIRCLE	% OF SCHOOLS HAVING GIRLS TOILET	AVERAGE PTR	AVERAGE SCR	% OF SCHOOLS HAVING PTR>60	% PASSED w.r.to NO APPEARED	INDEX	RANK
	<i>Normalized</i>	<i>Normalized</i>	<i>Normalized</i>	<i>Normalized</i>	<i>Normalized</i>		
CIRCLE-14	0.41	0.94	0.98	0.98	0.69	0.857251	1(First)
CIRCLE-12	0.53	0.94	0.88	0.89	0.82	0.845233	2(Second)
CIRCLE-3	0.7	1	1	0.94	0.2	0.822707	3(Third)
CIRCLE-BEHALA WEST	0.72	0.88	0.84	0.83	0.74	0.81659	4
CIRCLE-13	0.62	0.75	0.91	0.8	0.59	0.76048	5
CIRCLE-1	0.69	0.73	0.83	0.67	0.77	0.74058	6
CIRCLE-19	1	0.72	0.93	0.42	0.68	0.721959	7
CIRCLE-17	0.65	0.77	0.73	0.81	0.52	0.716639	8
CIRCLE-5	0.1	0.65	0.92	0.7	0.91	0.703574	9
CIRCLE-BEHALA	0.74	0.66	0.8	0.73	0.39	0.678241	10
CIRCLE-7	0.69	0.69	0.75	0.52	0.48	0.628396	11
CIRCLE-18	0.46	0.43	0.79	0.41	1	0.605561	12
CIRCLE-4	0	0.52	0.9	0.67	0.63	0.60518	13
CIRCLE-TOLLYGUNGE	0.42	0.72	0.47	0.79	0.48	0.603722	14
CIRCLE-10	0.96	0.45	0.54	0.46	0.68	0.571195	15
CIRCLE-8	0.28	0.48	0.83	0.36	0.84	0.567398	16
CIRCLE-15	0.27	0.53	0.73	0.58	0.38	0.536276	17
CIRCLE-2	0.03	0.62	0.48	1	0	0.513903	18
CIRCLE-11	0.7	0.5	0.81	0.09	0.55	0.503088	19
CIRCLE-6	0.78	0.53	0.84	0.17	0.27	0.502605	20
CIRCLE-16	0.51	0.56	0.25	0.65	0.21	0.446579	21
CIRCLE-9	0.8	0.16	0.25	0	0.63	0.291723	22
CIRCLE-ALIPORE	0.61	0	0	0.13	0.37	0.163755	23(Last)

DATA SOURCE: DISE 2009-10
 STAGE: ELEMENTARY (P+UP)
 METHOD: PRINCIPAL COMPONENT ANALYSIS(PCA), 5 VARIABLES
 SOFTWARE: ORACLE, SPSS, MS-EXCEL, Reference Book – EDI, Arun C Mehta, NUEPA

From the above table we get that Circle-14 ranks first in EDI, while Circle-Alipore is in last position.

Circle Alipore Performs Poor for Last Two Years

In EDI ranking:

Observation:

Salient Features of Circle Alipore

(132 – 141 KMC Wards)

- 1) Highly populated for Minority people.
- 2) People / Children get migrated seasonally either to Up / Bihar.
- 3) Predominance of child labour.
- 4) Children and Adults both are involved in small Textile Industry, “Zari” and “Tailoring” Work.
- 5) Highest OOSC prove fore of KMC.
- 6) Girl children are mostly studying at Non-formal education centers due to religious inhibitions for going to formal schools.
- 7) Need of formal **Urdu Schools**.
- 8) Good number of Madrasah and Maktab is there in comparison to other KMC wards. In these Madrasah & Maktab, religious educational practice goes on.
- 9) **School Mapping is strongly recommended.**

Note: - Observations and Suggestions in this respect from all readers will gladly be accepted.

For School Mapping

Medium wise No. of Schools:

All category, All Management

from DISE-2009-10

KMC Ward	Bengali		Hindi		Urdu	
	Primary	U.P.	Primary	U.P.	Primary	U.P.
WARD-1	12	7	13	1	4	0
WARD-2	14	9	8	5	0	0
WARD-3	10	9	6	1	9	4
WARD-4	13	2	4	1	0	0
WARD-5	7	1	2	0	3	0
WARD-6	4	4	18	5	5	1
WARD-7	12	5	2	0	0	0
WARD-8	6	5	3	1	0	0
WARD-9	3	0	0	0	0	0
WARD-10	14	8	1	0	0	0
WARD-11	5	1	6	0	0	0
WARD-12	5	4	4	2	0	0
WARD-13	12	1	5	1	0	0
WARD-14	19	7	5	1	0	0
WARD-15	11	3	3	1	0	0
WARD-16	6	5	4	0	0	0
WARD-17	6	4	2	0	0	0
WARD-18	4	2	5	1	0	0
WARD-19	7	1	2	0	0	0
WARD-20	7	4	7	1	0	0
WARD-21	3	0	7	0	0	0
WARD-22	0	0	14	3	0	0
WARD-23	2	0	11	2	0	0
WARD-24	5	2	17	4	0	0
WARD-25	6	4	8	3	1	1
WARD-26	9	5	3	1	0	0
WARD-27	5	5	2	3	0	0
WARD-28	11	5	5	0	2	0
WARD-29	4	0	2	0	12	2
WARD-30	11	3	4	2	0	0
WARD-31	9	4	12	3	0	0
WARD-32	9	7	5	0	1	1
WARD-33	13	4	3	0	0	0
WARD-34	15	14	0	0	0	0
WARD-35	12	6	4	0	0	0
WARD-36	4	2	5	3	1	1
WARD-37	8	6	2	0	4	1

KMC Ward	Bengali		Hindi		Urdu	
	Primary	U.P.	Primary	U.P.	Primary	U.P.
WARD-38	6	5	6	1	2	1
WARD-39	0	0	5	2	8	0
WARD-40	4	7	2	1	0	1
WARD-41	0	0	9	3	3	0
WARD-42	1	0	4	2	0	0
WARD-43	2	1	1	0	5	1
WARD-44	1	1	4	2	9	3
WARD-45	1	0	4	0	0	0
WARD-46	0	0	2	0	0	0
WARD-47	2	0	3	0	1	0
WARD-48	4	2	0	0	0	0
WARD-49	4	1	1	0	1	0
WARD-50	6	3	1	2	0	0
WARD-51	4	4	1	1	0	0
WARD-52	1	0	3	1	0	0
WARD-53	7	3	2	0	1	0
WARD-54	2	2	0	0	6	4
WARD-55	4	5	6	2	1	0
WARD-56	8	5	5	1	6	1
WARD-57	17	1	9	1	7	0
WARD-58	28	8	10	2	0	0
WARD-59	11	2	5	0	5	1
WARD-60	4	2	0	0	12	6
WARD-61	0	0	2	1	4	0
WARD-62	2	2	1	0	10	2
WARD-63	1	1	2	0	1	1
WARD-64	5	2	0	0	7	2
WARD-65	5	1	8	0	11	2
WARD-66	13	4	3	1	3	2
WARD-67	17	5	7	0	0	0
WARD-68	8	6	1	0	0	0
WARD-69	10	3	0	0	1	0
WARD-70	4	4	1	2	0	0
WARD-71	3	0	2	1	0	0
WARD-72	9	7	5	3	0	0
WARD-73	5	4	1	1	0	0
WARD-74	5	1	3	0	0	0
WARD-75	0	0	1	0	2	0
WARD-76	7	3	2	1	3	0
WARD-77	10	3	3	2	6	2
WARD-78	6	2	7	3	6	6
WARD-79	2	1	12	3	5	1
WARD-80	4	2	15	8	0	0

KMC Ward	Bengali		Hindi		Urdu	
	Primary	U.P.	Primary	U.P.	Primary	U.P.
WARD-81	23	4	6	0	0	0
WARD-82	16	4	3	0	0	0
WARD-83	7	3	0	0	0	0
WARD-84	5	1	2	1	0	0
WARD-85	9	5	4	2	0	0
WARD-86	7	6	2	1	0	0
WARD-87	11	7	0	0	0	0
WARD-88	10	6	1	1	0	0
WARD-89	15	6	8	6	0	0
WARD-90	4	4	1	0	0	0
WARD-91	15	9	2	0	0	0
WARD-92	17	8	2	0	0	0
WARD-93	16	6	6	0	1	0
WARD-94	12	6	2	1	0	0
WARD-95	14	7	2	1	0	0
WARD-96	9	9	2	0	0	0
WARD-97	10	5	0	0	0	0
WARD-98	14	5	3	0	0	0
WARD-99	13	5	0	0	0	0
WARD-100	17	7	2	0	0	0
WARD-101	9	3	0	0	0	0
WARD-102	8	4	0	0	0	0
WARD-103	8	3	1	0	0	0
WARD-104	15	6	2	0	0	0
WARD-105	7	6	1	0	0	0
WARD-106	15	3	0	1	0	0
WARD-107	7	0	0	0	0	0
WARD-108	14	3	2	1	0	0
WARD-109	15	1	0	0	0	0
WARD-110	4	1	0	0	0	0
WARD-111	13	1	0	0	0	0
WARD-112	10	1	2	1	0	0
WARD-113	9	3	2	0	0	0
WARD-114	11	3	0	0	1	0
WARD-115	12	4	1	0	0	0
WARD-116	12	0	4	0	0	0
WARD-117	6	3	1	0	0	0
WARD-118	7	2	3	0	0	0
WARD-119	5	2	0	0	0	0
WARD-120	8	5	2	1	0	0
WARD-121	7	4	3	0	0	0
WARD-122	7	4	0	0	0	0
WARD-123	13	9	2	0	0	0

KMC Ward	Bengali		Hindi		Urdu	
	Primary	U.P.	Primary	U.P.	Primary	U.P.
WARD-124	11	7	1	0	0	0
WARD-125	15	3	0	0	0	0
WARD-126	25	4	0	0	0	0
WARD-127	18	3	0	0	0	0
WARD-128	15	2	1	0	0	0
WARD-129	14	4	0	0	0	0
WARD-130	5	5	0	0	0	0
WARD-131	10	6	2	0	0	0
WARD-132	6	3	2	0	0	0
WARD-133	17	4	7	2	2	0
WARD-134	3	0	3	0	11	2
WARD-135	2	0	4	0	12	4
WARD-136	6	2	0	0	3	2
WARD-137	1	1	1	1	4	1
WARD-138	7	0	2	0	4	0
WARD-139	14	3	0	0	2	0
WARD-140	13	4	1	0	1	1
WARD-141	19	3	3	0	4	1

Note: - Some of the wards mainly 132-141 have either no Upper Primary Urdu Schools or insufficient number of Urdu Schools, w.r.to Muslim population, which implies that some Urdu Medium Schools are required here.

Some of the Hindi speaking dense populated wards also lacks Hindi Medium Upper Primary Schools. For example, wards under Circle-4 and Circle-6 like 21, 26, 39, 42, 43, 44 lack Hindi Medium Schools w.r.to their population. Therefore, U.P. Hindi Medium Schools are required here.

In this context, GIS mapping may be consulted along with the DISE for school mapping as per RTE. These activities are going on in SSM Kolkata.

CIRCLE-WISE DATA ANALYSIS

Circle-Wise Data Analysis- Primary

CIRCLE	ENROLMENT			GPI	% of SC ENROLMENT	% of ST ENROLMENT	% of MINORITY ENROLMENT
	BOYS	GIRLS	TOTAL				
CIRCLE-1	5014	4415	9429	88.05	2.34	0.52	16.32
CIRCLE-2	3155	3506	6661	111.13	1.88	0.02	19.38
CIRCLE-3	1643	2840	4483	172.85	1.25	0.00	0.87
CIRCLE-4	3058	2383	5441	77.93	1.12	0.00	1.36
CIRCLE-5	2459	3411	5870	138.71	2.50	0.32	2.83
CIRCLE-6	3777	4077	7854	107.94	2.25	0.22	18.82
CIRCLE-7	5511	5978	11489	108.47	1.11	0.24	6.08
CIRCLE-8	6842	5868	12710	85.76	2.46	0.39	15.92
CIRCLE-9	10592	10496	21088	99.09	2.17	0.03	36.98
CIRCLE-10	8649	7557	16206	87.37	1.76	0.09	36.57
CIRCLE-11	6155	11216	17371	182.23	1.62	0.21	5.16
CIRCLE-12	5587	6054	11641	108.36	2.30	0.16	2.41
CIRCLE-13	2411	2375	4786	98.51	4.35	0.08	2.19
CIRCLE-14	3060	2634	5694	86.08	0.11	0.00	1.58
CIRCLE-15	3925	3109	7034	79.21	0.45	0.03	2.52
CIRCLE-16	6387	6003	12390	93.99	7.72	0.46	17.10
CIRCLE-17	6956	6215	13171	89.35	1.92	0.52	7.21
CIRCLE-18	5362	4810	10172	89.71	3.49	1.09	7.53
CIRCLE-19	2706	2616	5322	96.67	0.00	0.00	0.28
CIRCLE-ALIPORE	11398	11962	23360	104.95	1.99	0.08	54.24
CIRCLE-BEHALA	5858	5571	11429	95.10	1.29	0.23	3.32
CIRCLE-BEHALA WEST	7022	7669	14691	109.21	0.95	0.29	5.45
CIRCLE-TOLLYGUNGE	8494	8321	16815	97.96	12.72	0.45	5.17

Circle-Wise GPI- Primary

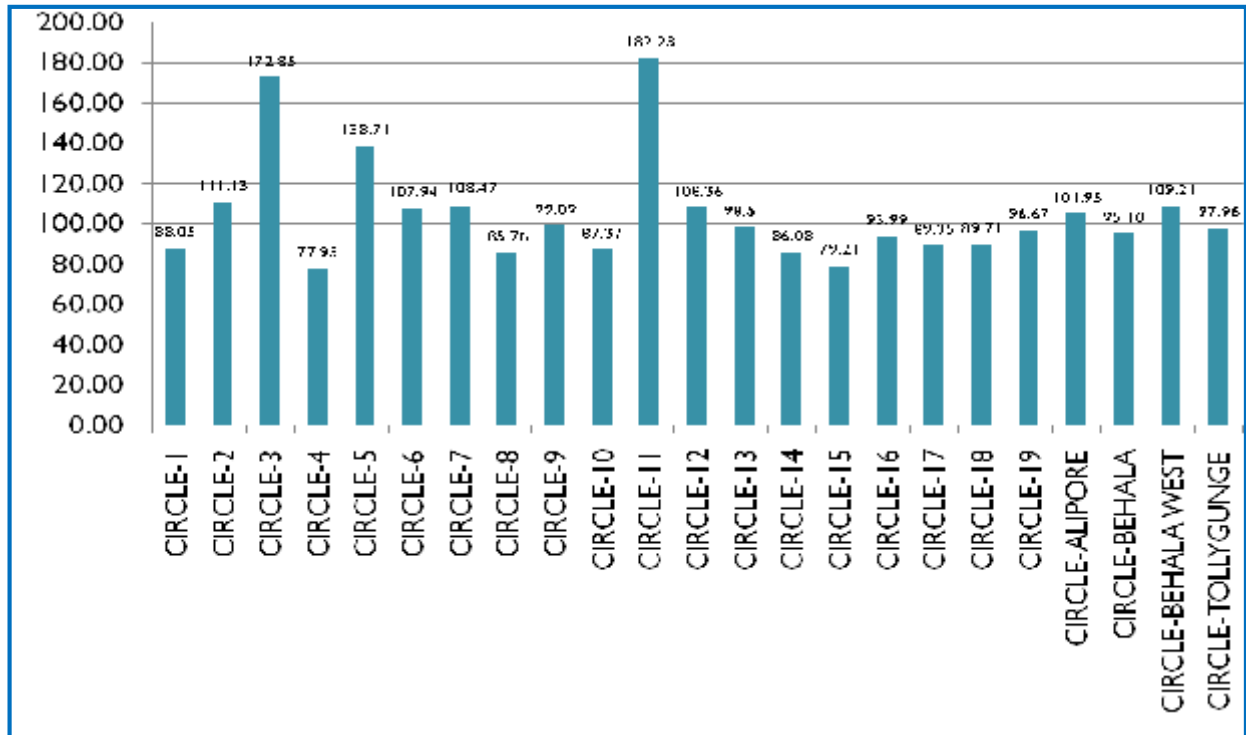

Circle-Wise % of SC Enrolment- Primary

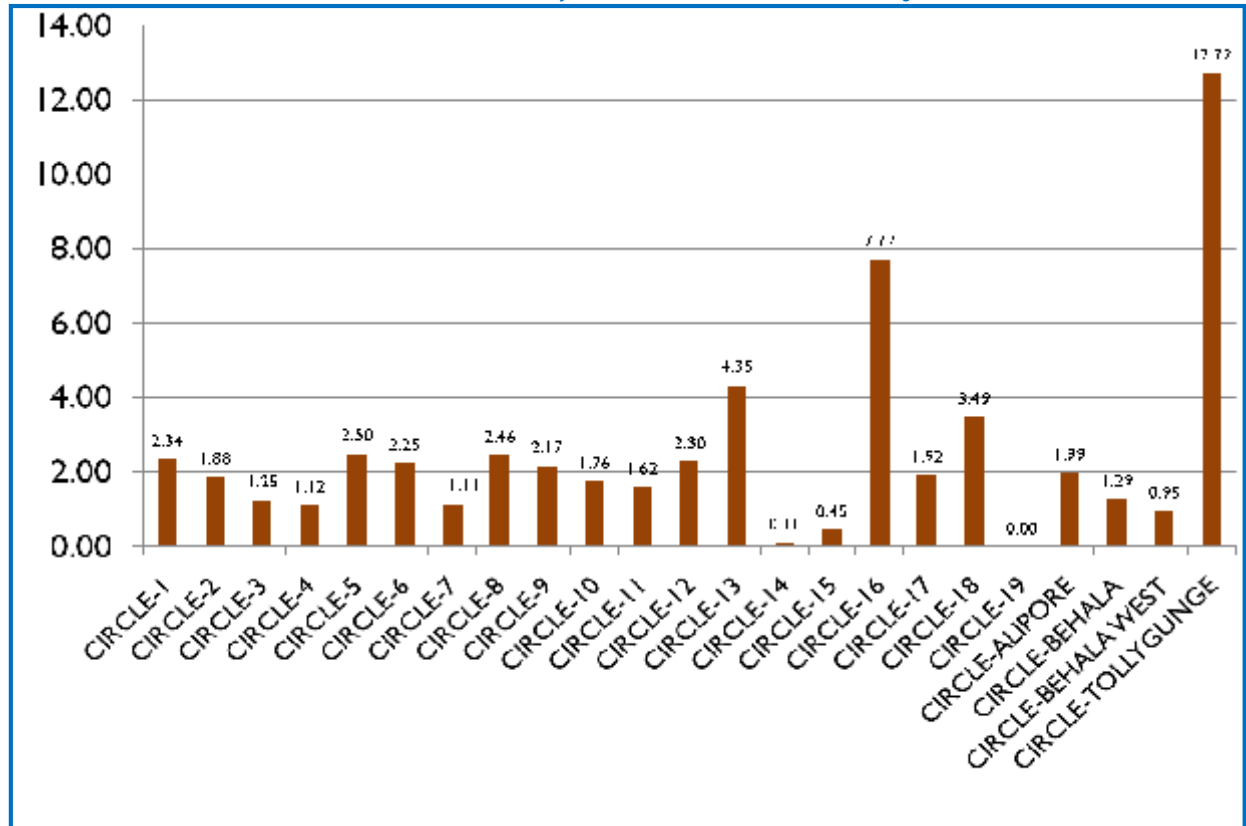

Circle-wise % of ST Enrolment- Primary

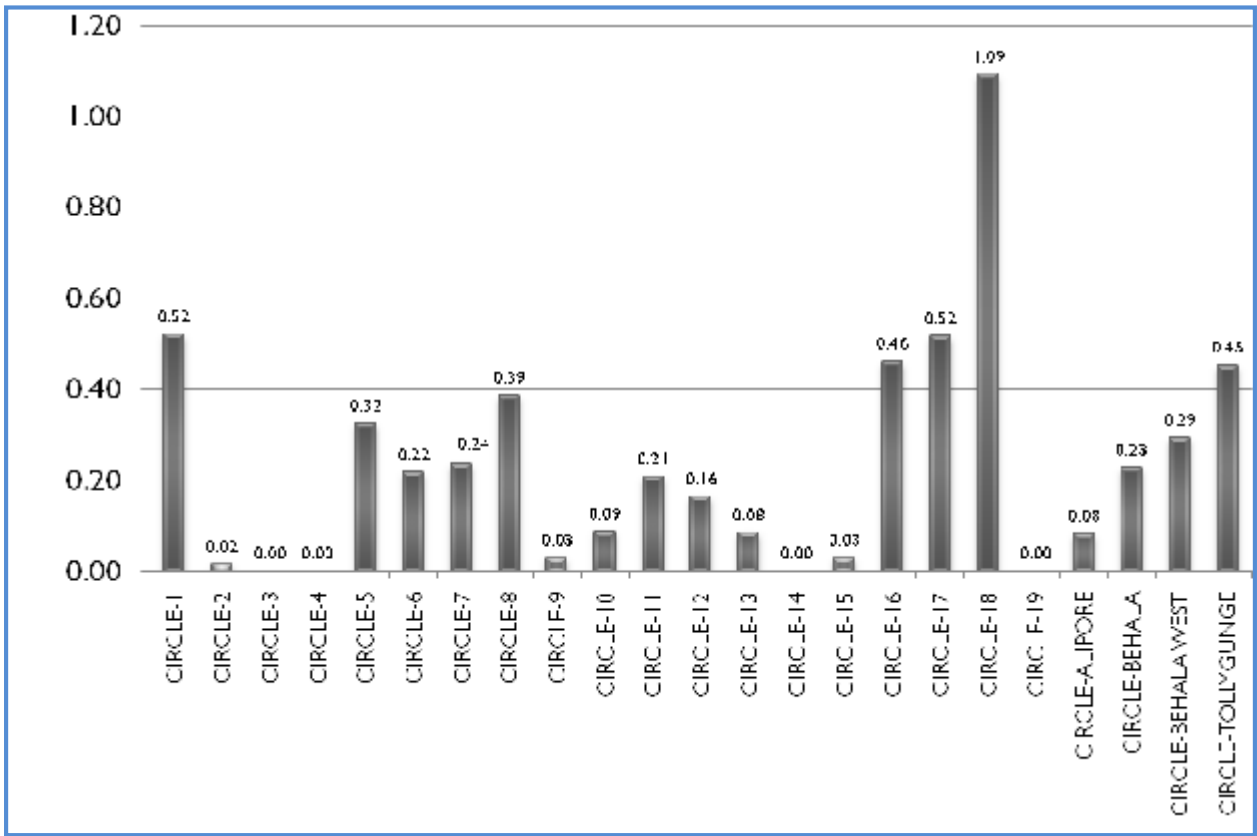

Circle-wise % of Minority Enrolment- Primary

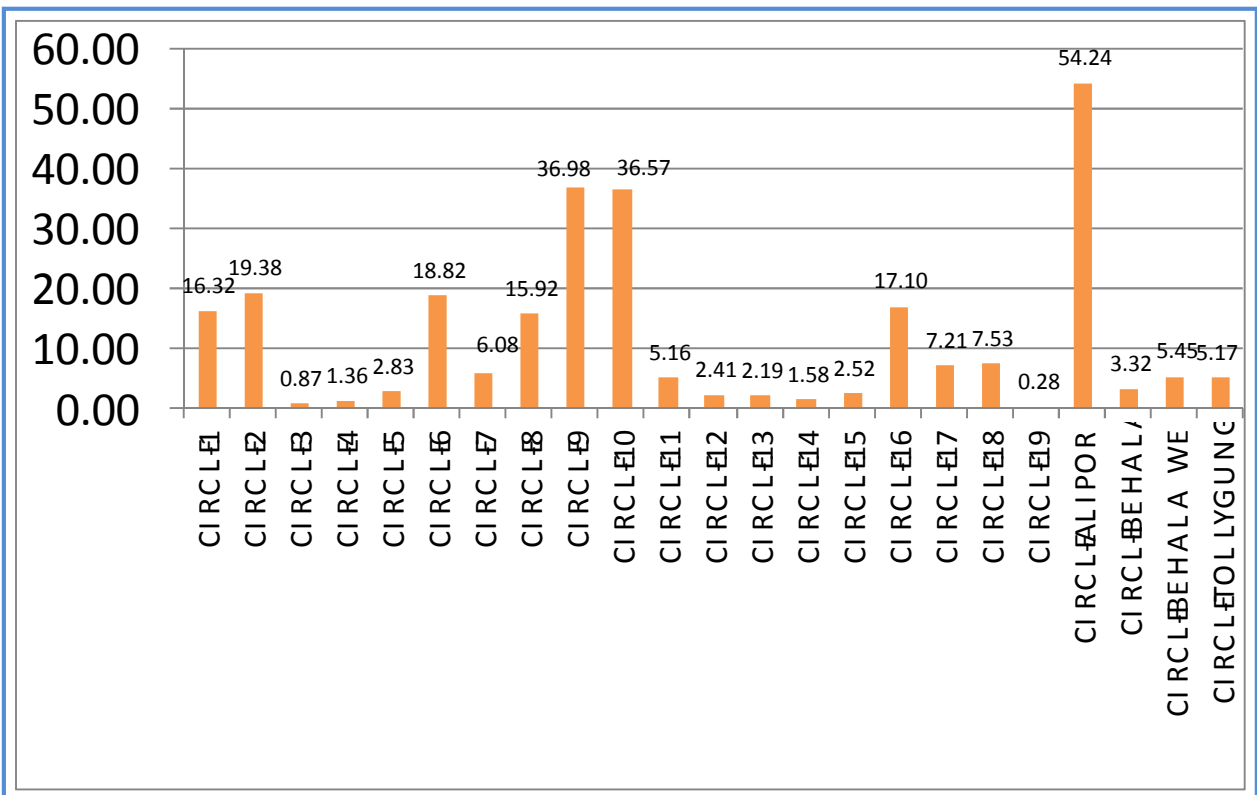

Circle-Wise Data Analysis- Upper Primary

CIRCLE	ENROLMENT			GPI	% of SC ENROLMENT	% of ST ENROLMENT	% of MINORITY ENROLMENT
	BOYS	GIRLS	TOTAL				
CIRCLE-1	3964	4629	8593	116.78	7.13	1.16	17.12
CIRCLE-2	3734	3212	6946	86.02	7.14	0.19	8.48
CIRCLE-3	2056	3109	5165	151.22	3.76	0.37	0.83
CIRCLE-4	2797	1993	4790	71.25	2.15	0.21	1.23
CIRCLE-5	2879	2590	5469	89.96	6.03	0.46	0.75
CIRCLE-6	3725	3537	7262	94.95	5.47	0.62	25.17
CIRCLE-7	5541	8005	13546	144.47	10.76	0.45	1.40
CIRCLE-8	6692	6019	12711	89.94	6.82	0.95	18.43
CIRCLE-9	7960	9242	17202	116.11	5.22	0.00	44.54
CIRCLE-10	8166	6864	15030	84.06	6.37	0.55	38.79
CIRCLE-11	8408	11285	19693	134.22	4.32	0.37	3.19
CIRCLE-12	6190	6352	12542	102.62	10.37	0.62	3.17
CIRCLE-13	2275	3251	5526	142.90	10.28	1.68	2.23
CIRCLE-14	4076	2470	6546	60.60	9.32	0.24	0.95
CIRCLE-15	3959	2673	6632	67.52	11.22	0.24	0.75
CIRCLE-16	3613	4457	8070	123.36	19.36	1.50	9.11
CIRCLE-17	5136	6671	11807	129.89	12.13	0.62	8.83
CIRCLE-18	4070	5151	9221	126.56	7.56	0.86	4.67
CIRCLE-19	2881	1724	4605	59.84	2.15	0.00	1.22
CIRCLE-ALIPORE	8847	11766	20613	132.99	4.91	0.22	62.03
CIRCLE-BEHALA	7105	7437	14542	104.67	13.73	0.39	6.00
CIRCLE-BEHALA WEST	4982	5960	10942	119.63	15.69	0.58	4.33
CIRCLE-TOLLYGUNGE	5462	6130	11592	112.23	41.50	0.79	2.38

Circle-Wise GPI- Upper Primary

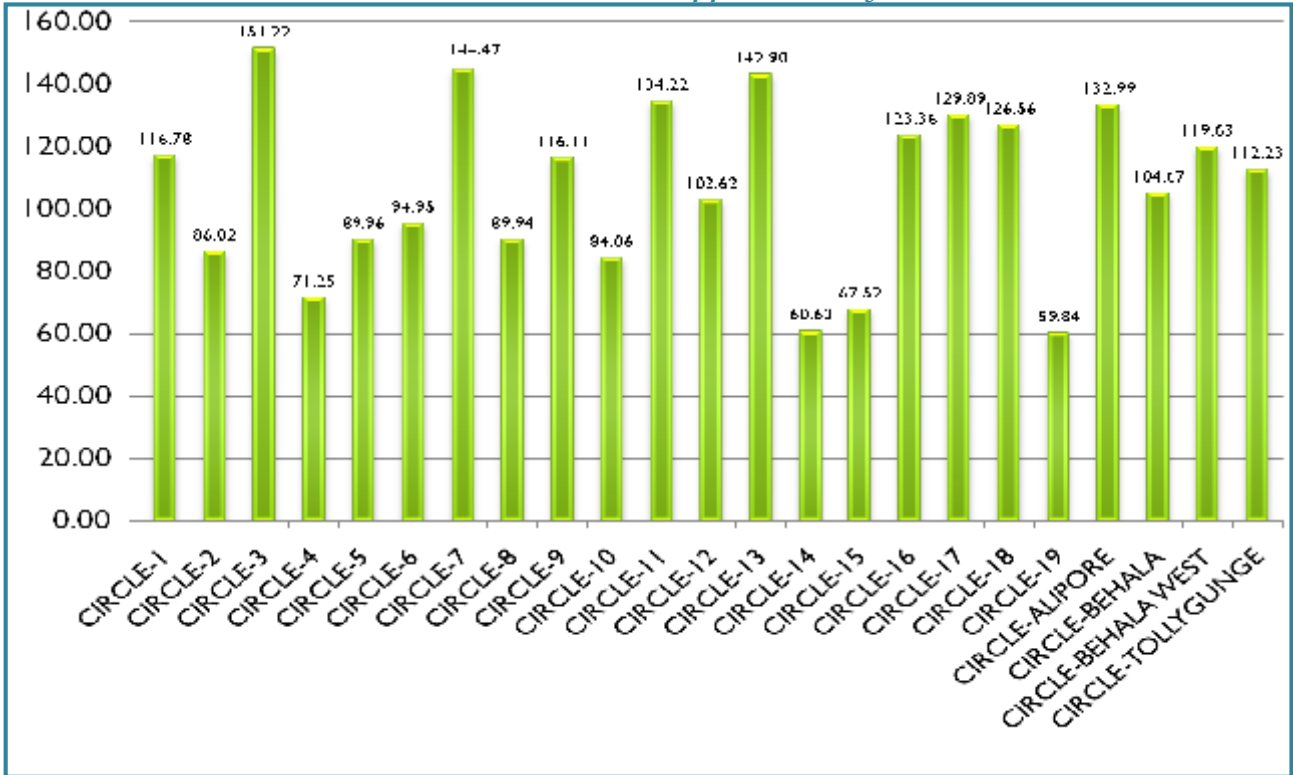

Circle-wise % of SC Enrolment- Upper Primary

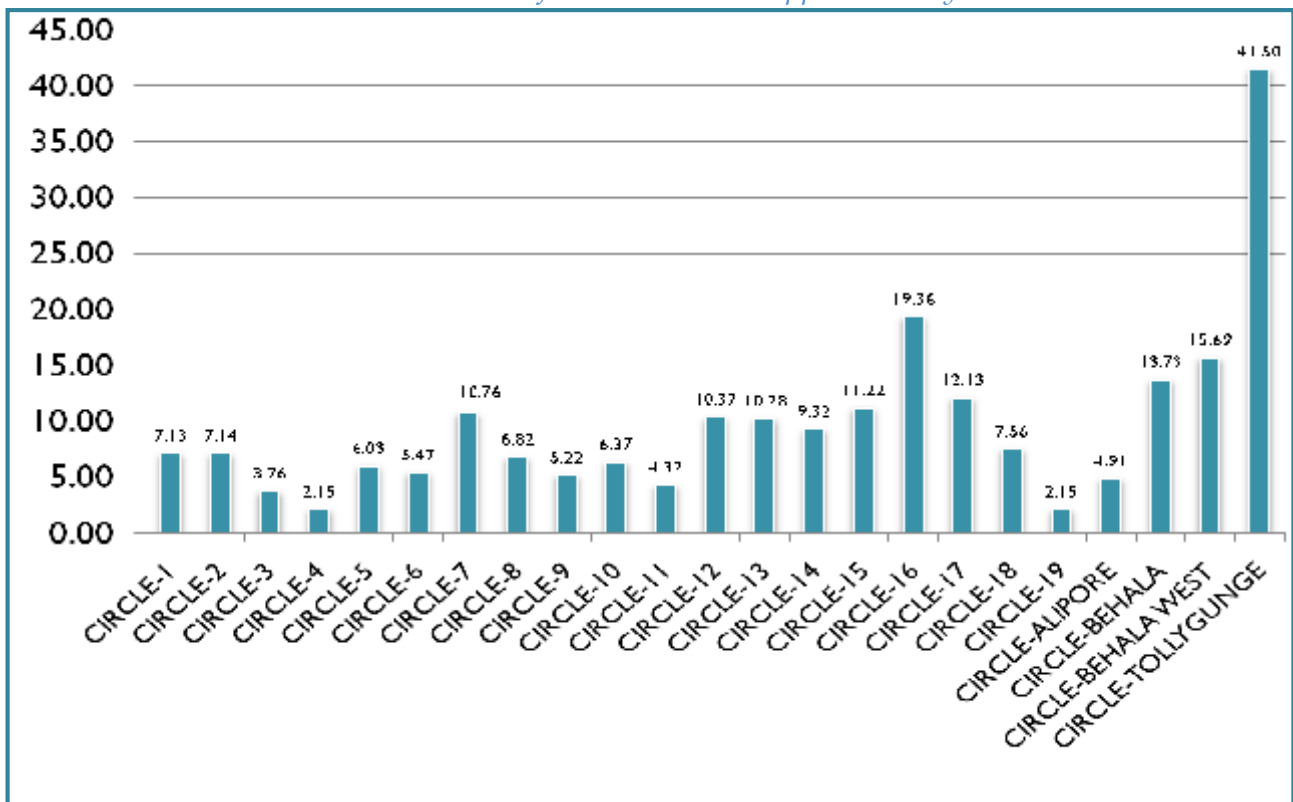

Circle-wise % of ST Enrolment- Upper Primary

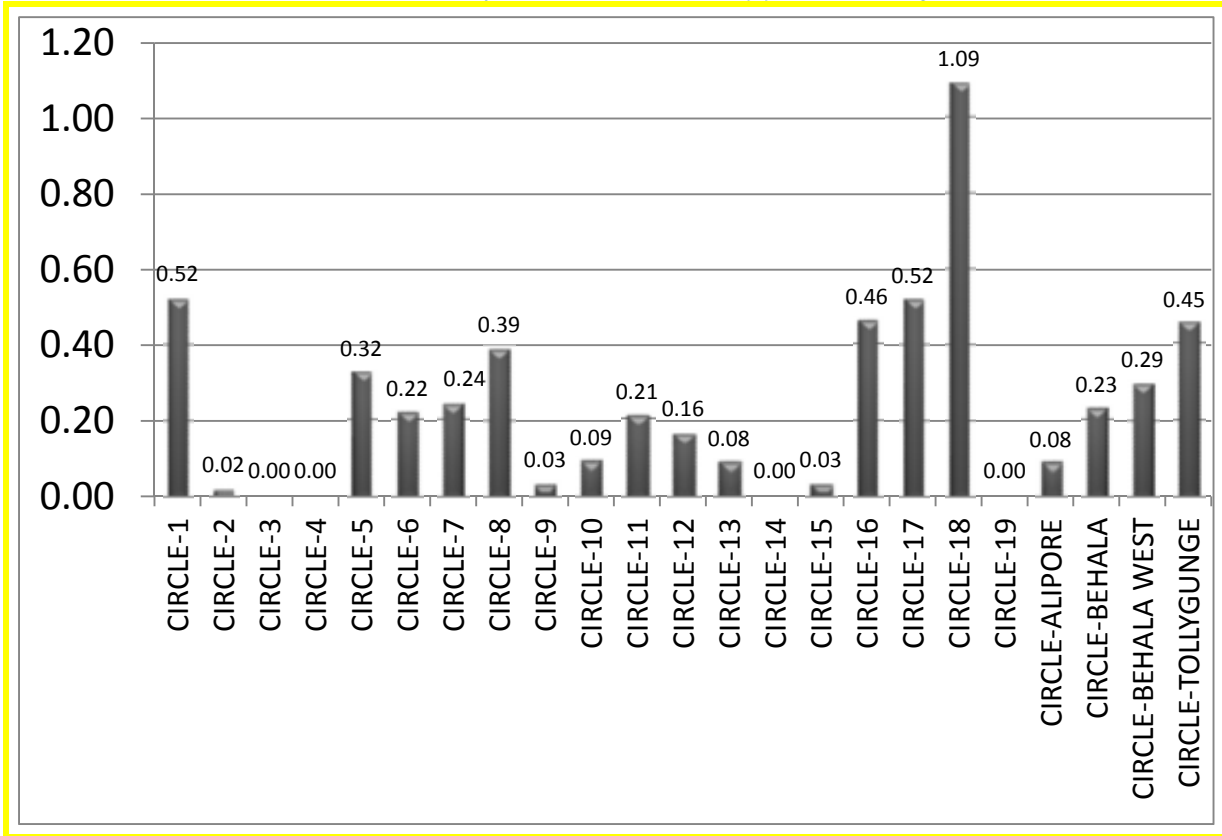

Circle-wise % of Minority Enrolment- Upper Primary

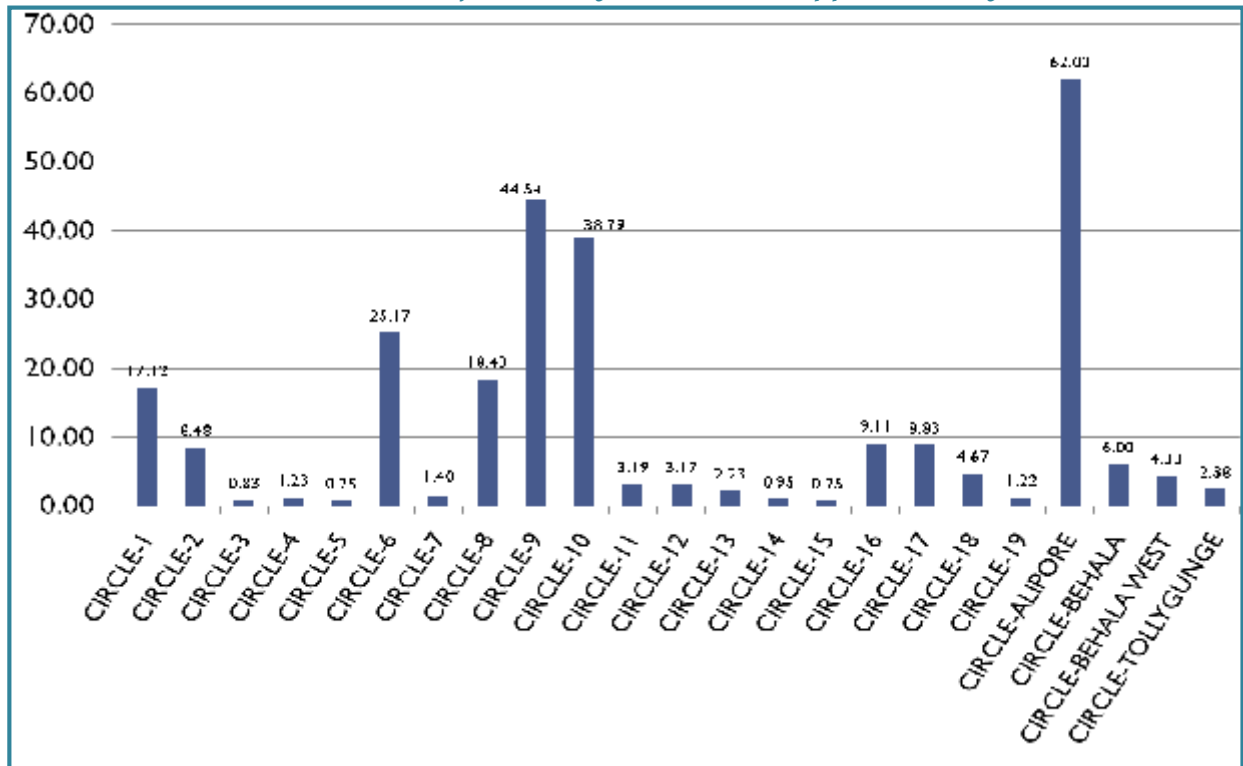

CASTE WISE, CIRCLE WISE GENDER PARITY INDEX (GPI) - PRIMARY

CIRCLE	SC ENROLMENT			ST ENROLMENT			MINORITY ENROLMENT		
	BOYS	GIRLS	GPI	BOYS	GIRLS	GPI	BOYS	GIRLS	GPI
CIRCLE-1	122	99	81	26	23	88	828	711	85.87
CIRCLE-2	43	82	191	0	1	200	615	676	109.92
CIRCLE-3	45	11	24	0	0	0	19	20	105.26
CIRCLE-4	36	25	69	0	0	0	51	23	45.10
CIRCLE-5	56	91	163	11	8	73	78	88	112.82
CIRCLE-6	131	46	35	11	6	55	1039	439	42.25
CIRCLE-7	39	88	226	15	12	80	402	297	73.88
CIRCLE-8	194	119	61	27	22	81	1106	917	82.91
CIRCLE-9	259	198	76	3	3	100	4208	3590	85.31
CIRCLE-10	157	128	82	8	6	75	3017	2910	96.45
CIRCLE-11	173	109	63	30	6	20	173	724	418.50
CIRCLE-12	109	159	146	5	14	280	138	143	103.62
CIRCLE-13	100	108	108	2	2	100	54	51	94.44
CIRCLE-14	5	1	20	0	0	0	48	42	87.50
CIRCLE-15	23	9	39	1	1	100	85	92	108.24
CIRCLE-16	472	484	103	20	37	185	1038	1081	104.14
CIRCLE-17	211	42	20	40	28	70	454	495	109.03
CIRCLE-18	217	138	64	85	26	31	562	204	36.30
CIRCLE-19	0	0	0	0	0	0	12	3	25.00
CIRCLE-ALIPORE	225	239	106	8	11	138	6464	6207	96.02
CIRCLE-BEHALA	73	74	101	20	6	30	164	216	131.71
CIRCLE-BEHALA WEST	94	46	49	22	21	95	437	364	83.30
CIRCLE-TOLLYGUNGE	1106	1033	93	39	37	95	474	395	83.33

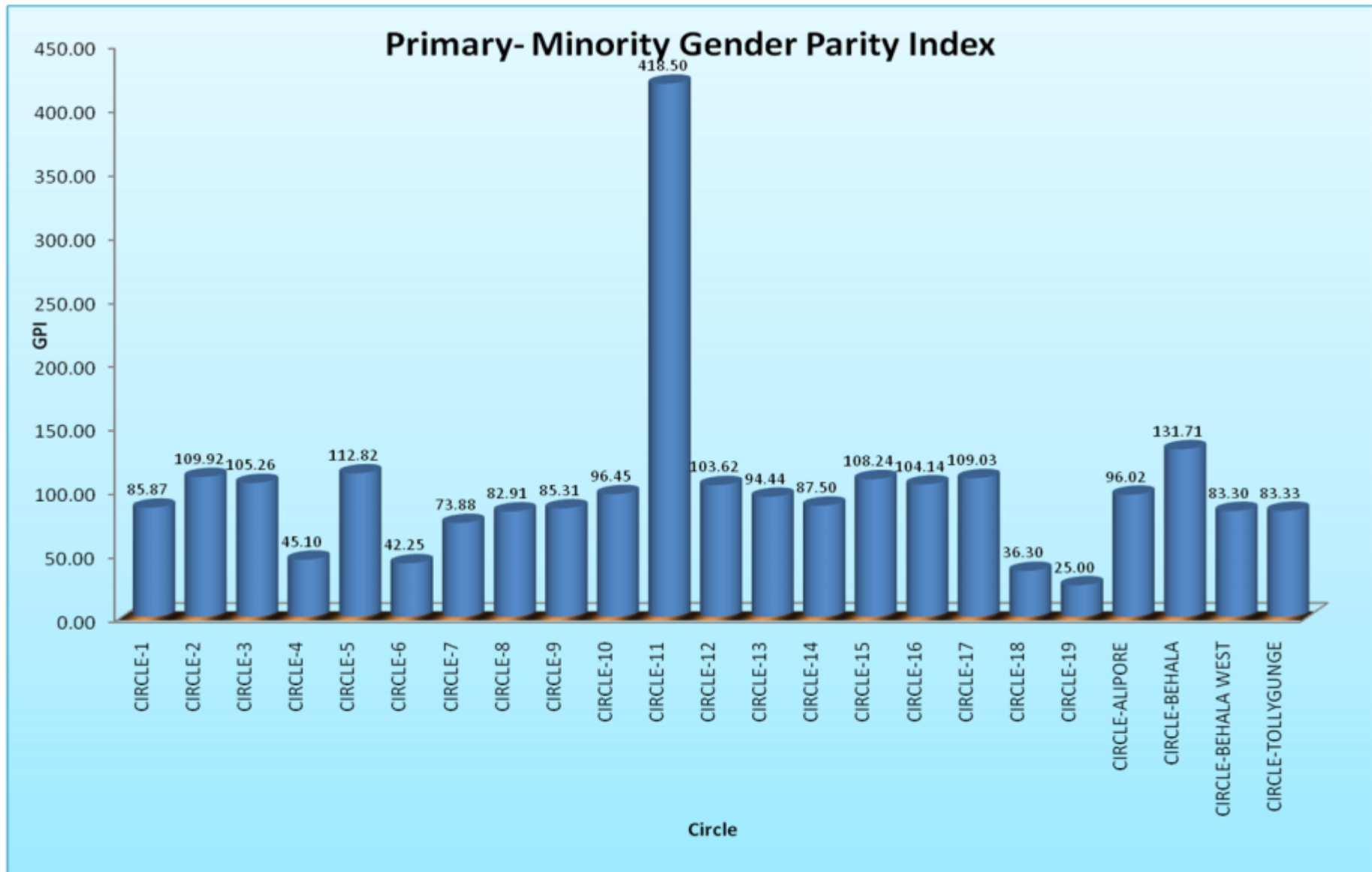

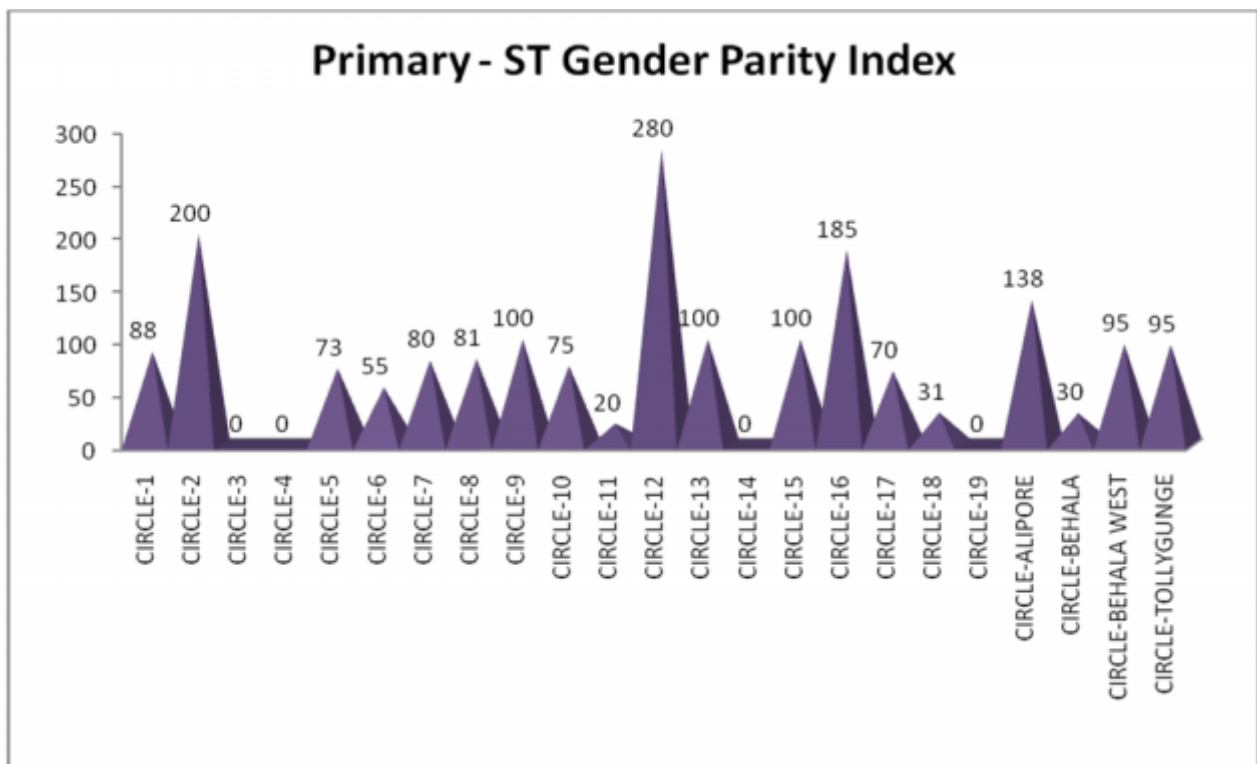
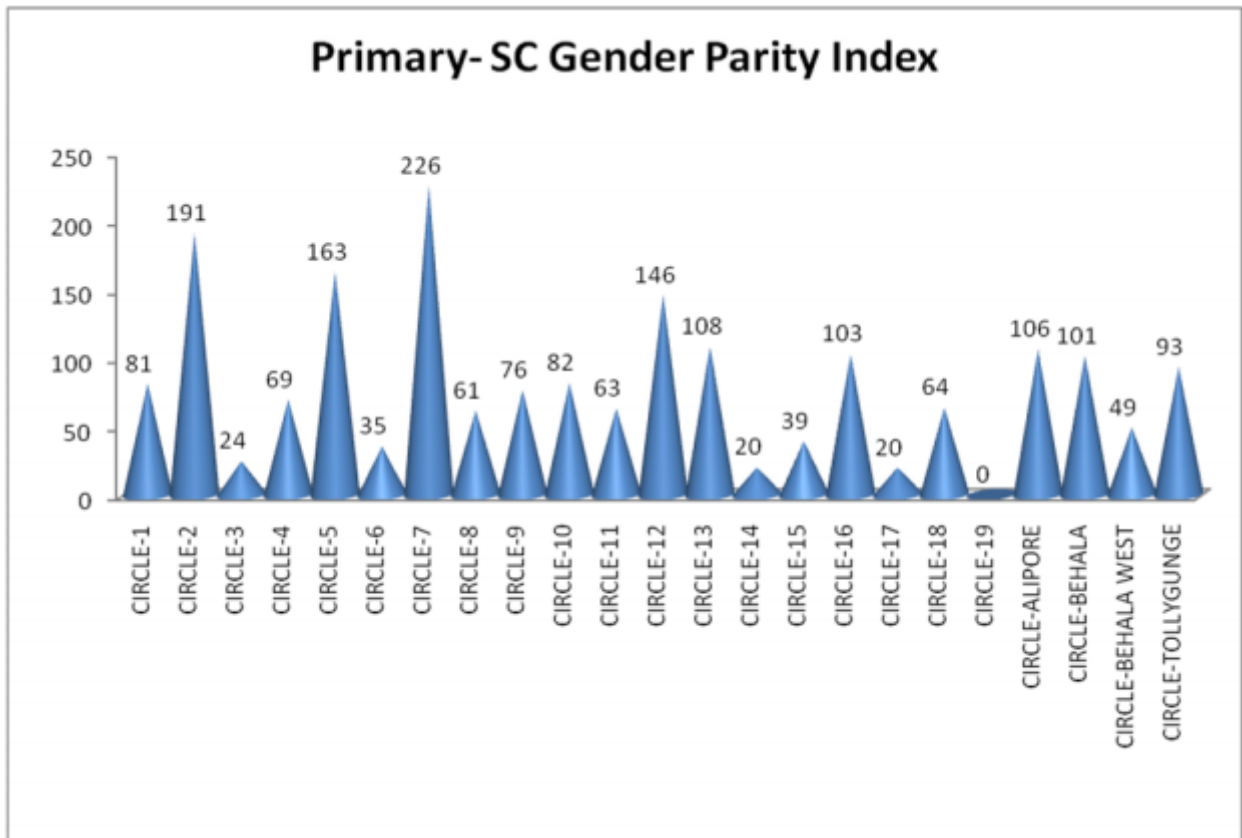

In the above Graph for SC and ST GPI, 0(Zero) values shown for some circles are actually undefined, and it is forcibly made for graphical representation.

CASTE WISE, CIRCLE WISE GENDER PARITY INDEX (GPI) - UPPER PRIMARY

CIRCLE	MINORITY ENROLMENT			SC ENROLMENT			ST ENROLMENT		
	BOYS	GIRLS	GPI	BOYS	GIRLS	GPI	BOYS	GIRLS	GPI
CIRCLE-1	739	732	99.05	214	399	186.45	52	48	92.31
CIRCLE-2	342	247	72.22	368	128	34.78	11	2	18.18
CIRCLE-3	13	30	230.77	114	80	70.18	0	19	--
CIRCLE-4	37	22	59.46	90	13	14.44	10	0	0.00
CIRCLE-5	37	4	10.81	192	138	71.88	16	9	56.25
CIRCLE-6	1229	599	48.74	266	131	49.25	40	5	12.50
CIRCLE-7	104	86	82.69	557	901	161.76	9	52	577.78
CIRCLE-8	1022	1321	129.26	571	296	51.84	56	65	116.07
CIRCLE-9	2781	4881	175.51	592	306	51.69	0	0	0.00
CIRCLE-10	2938	2892	98.43	719	239	33.24	72	10	13.89
CIRCLE-11	256	372	145.31	460	390	84.78	41	31	75.61
CIRCLE-12	143	254	177.62	752	549	73.01	39	39	100.00
CIRCLE-13	32	91	284.38	224	344	153.57	27	66	244.44
CIRCLE-14	34	28	82.35	290	320	110.34	12	4	33.33
CIRCLE-15	37	13	35.14	400	344	86.00	9	7	77.78
CIRCLE-16	290	445	153.45	737	825	111.94	47	74	157.45
CIRCLE-17	392	651	166.07	593	839	141.48	43	30	69.77
CIRCLE-18	342	89	26.02	362	335	92.54	16	63	393.75
CIRCLE-19	43	13	30.23	88	11	12.50	0	0	0.00
CIRCLE-ALIPORE	4999	7787	155.77	514	498	96.89	30	16	53.33
CIRCLE-BEHALA	419	454	108.35	1105	892	80.72	35	23	65.71
CIRCLE-BEHALA WEST	154	320	207.79	868	849	97.81	18	45	250.00
CIRCLE-TOLLYGUNGE	134	142	105.97	2586	2225	86.04	35	57	162.86

UP - Minority Gender Parity Index

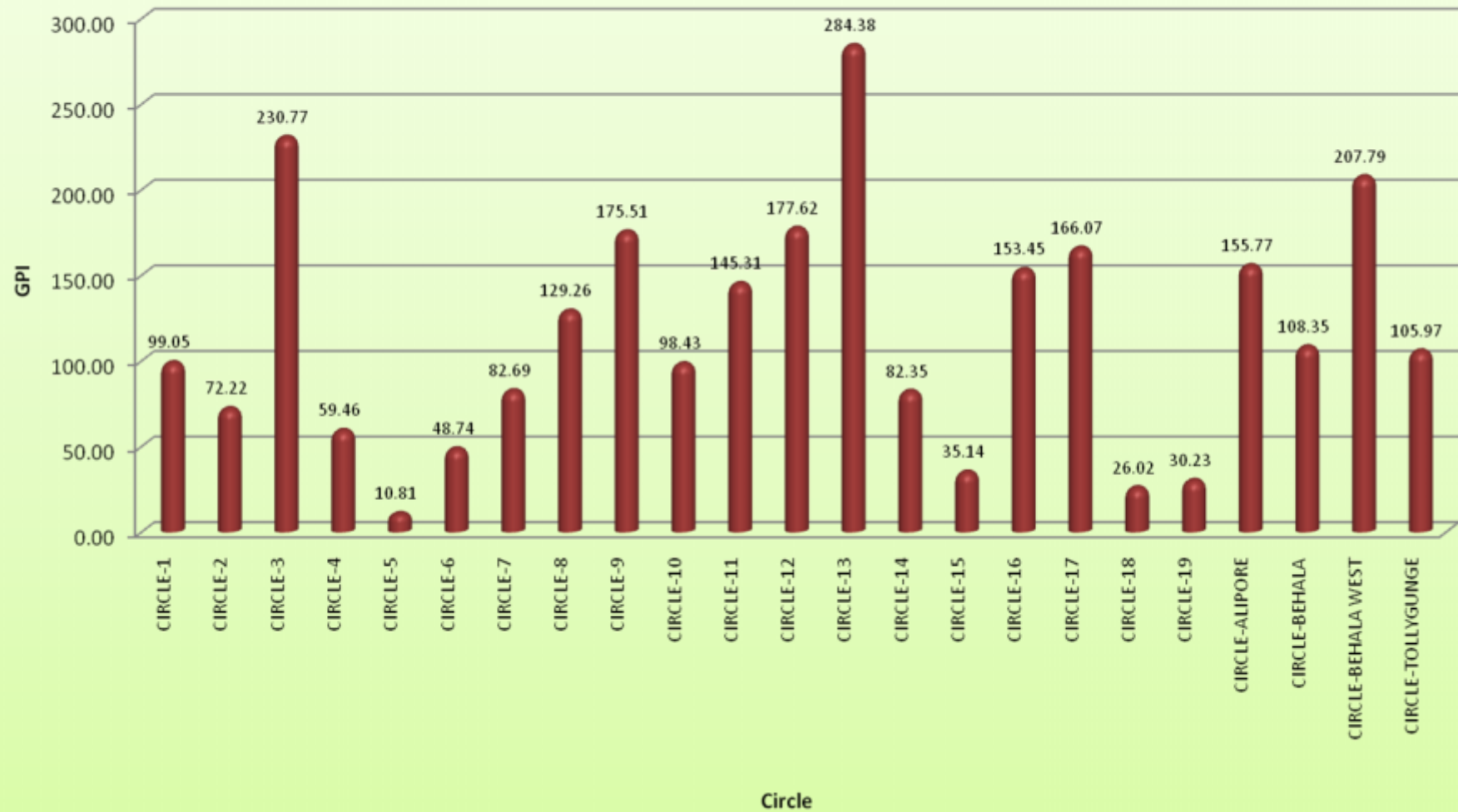

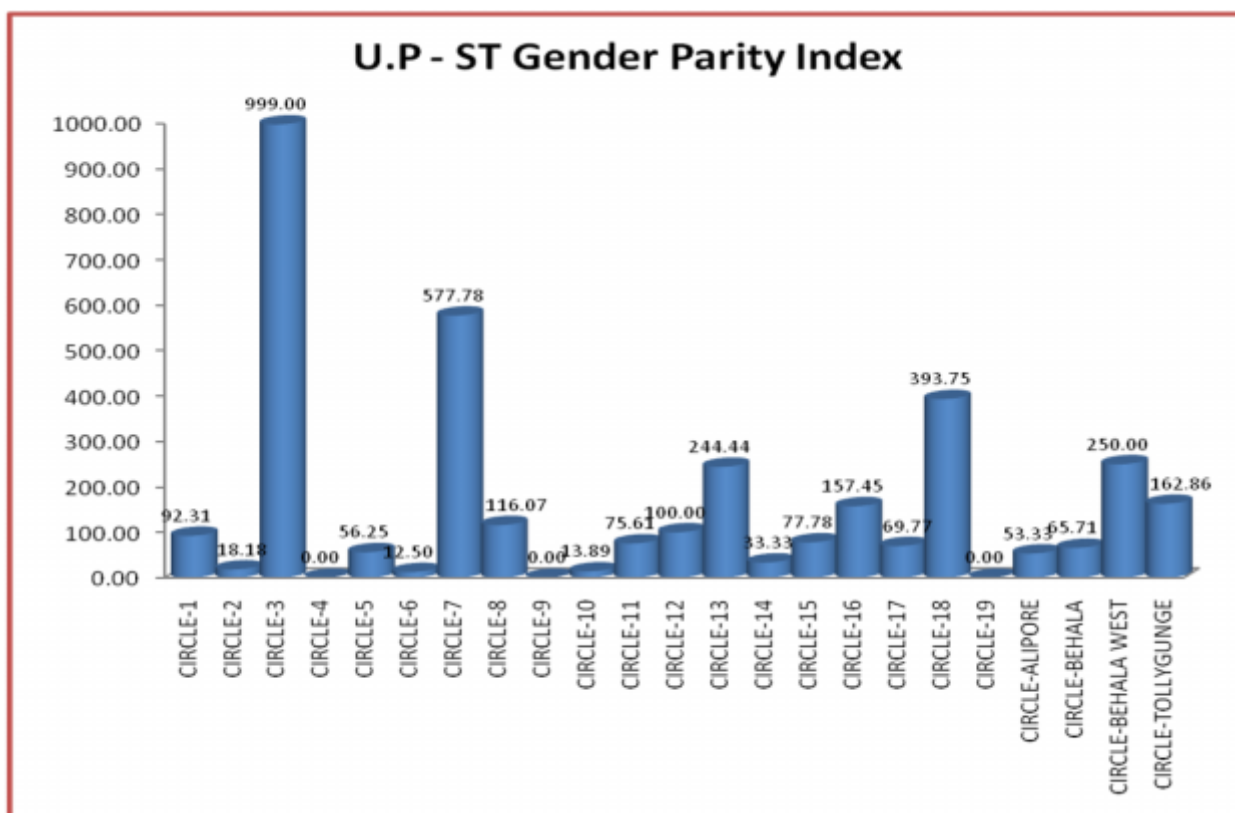
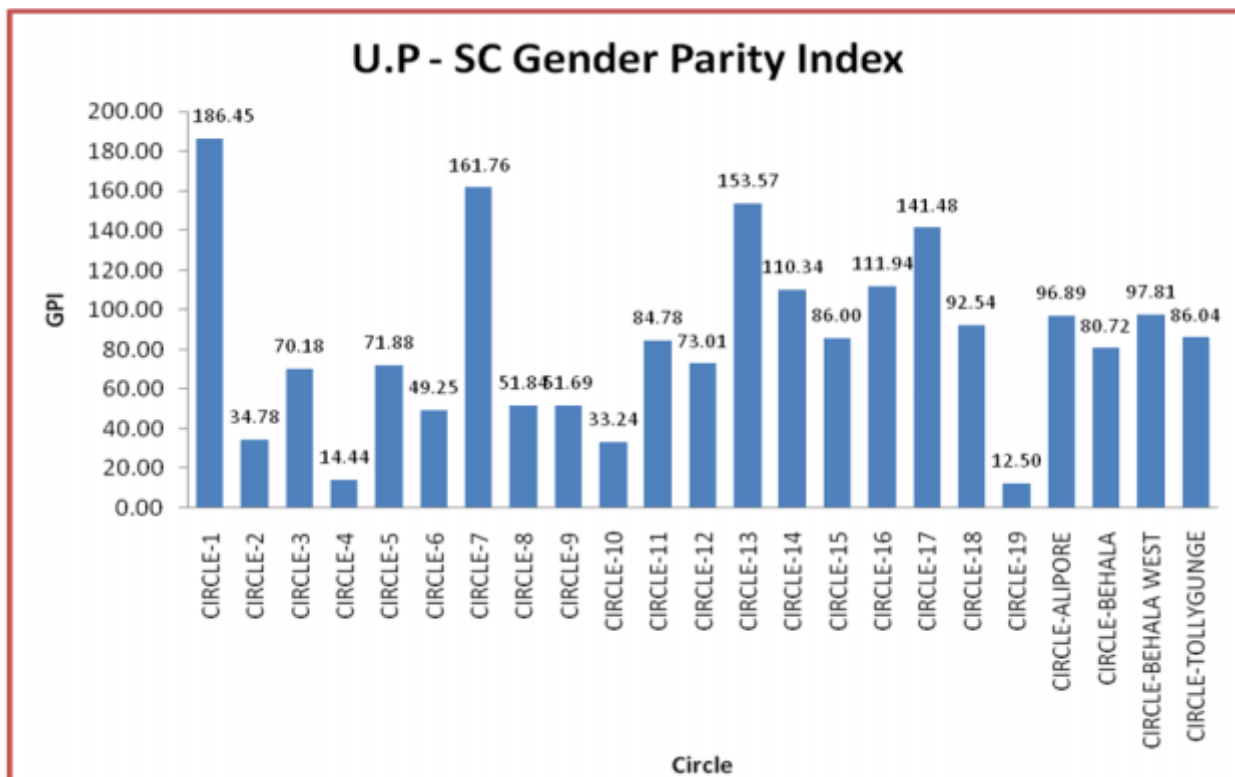

In the above graph for U.P. ST GPI, value for Circle-3 (999) has been replaced for infinite value to depict it in chart. Moreover, 0(Zero) values for some circles are also undefined.

Circle-wise - Examination Result Analysis

PRIMARY

RESULT ANALYSIS FROM DISE 2009-10 ALL MANAGEMENT										
CIRCLE	Class IV/V									
	APPEARED		PASSED		PASSED WITH > 60%		% OF PASSED w.r.to APPEARED		% OF PASSED WITH > 60% w.r to APPEARED	
	BOYS	GIRLS	BOYS	GIRLS	BOYS	GIRLS	BOYS	GIRLS	BOYS	GIRLS
CIRCLE-1	1954	1872	1892	1802	903	1025	96.83	96.26	46.21	54.75
CIRCLE-2	1529	1239	1305	1196	538	535	85.35	96.53	35.19	43.18
CIRCLE-3	705	1244	669	1189	386	695	94.89	95.58	54.75	55.87
CIRCLE-4	912	727	878	705	549	545	96.27	96.97	60.20	74.97
CIRCLE-5	1221	1247	1187	1225	673	602	97.22	98.24	55.12	48.28
CIRCLE-6	1694	1794	1591	1619	801	838	93.92	90.25	47.28	46.71
CIRCLE-7	2984	3028	2888	2849	1398	1325	96.78	94.09	46.85	43.76
CIRCLE-8	2443	2090	2382	2028	1172	1152	97.50	97.03	47.97	55.12
CIRCLE-9	3652	3863	3461	3625	1720	1589	94.77	93.84	47.10	41.13
CIRCLE-10	3265	2774	3138	2660	1293	1252	96.11	95.89	39.60	45.13
CIRCLE-11	2948	4381	2874	4096	1644	2224	97.49	93.49	55.77	50.76
CIRCLE-12	2523	2752	2421	2680	1195	1222	95.96	97.38	47.36	44.40
CIRCLE-13	1052	1177	1011	1118	601	552	96.10	94.99	57.13	46.90
CIRCLE-14	1122	981	1067	959	481	447	95.10	97.76	42.87	45.57
CIRCLE-15	1695	1396	1585	1327	864	690	93.51	95.06	50.97	49.43
CIRCLE-16	1971	1757	1894	1587	900	779	96.09	90.32	45.66	44.34
CIRCLE-17	2938	2898	2730	2811	1886	1514	92.92	97.00	64.19	52.24
CIRCLE-18	2285	2340	2225	2286	1389	1697	97.37	97.69	60.79	72.52
CIRCLE-19	1318	728	1257	707	630	430	95.37	97.12	47.80	59.07
CIRCLE-ALIPORE	4318	4942	4052	4537	1952	2029	93.84	91.80	45.21	41.06
CIRCLE-BEHALA	3360	3179	3194	2974	1480	1262	95.06	93.55	44.05	39.70
CIRCLE-BEHALA WEST	2903	3272	2761	3152	1590	1719	95.11	96.33	54.77	52.54
CIRCLE-TOLLYGUNGE	2700	2952	2539	2748	1319	1295	94.04	93.09	48.85	43.87
TOTAL	51492	52633	49001	49880	25364	25418	95.16	94.77	49.26	48.29

The Graphical representation of the above table is as follows:-

PRIMARY- CIRCLE WISE % OF PASSED

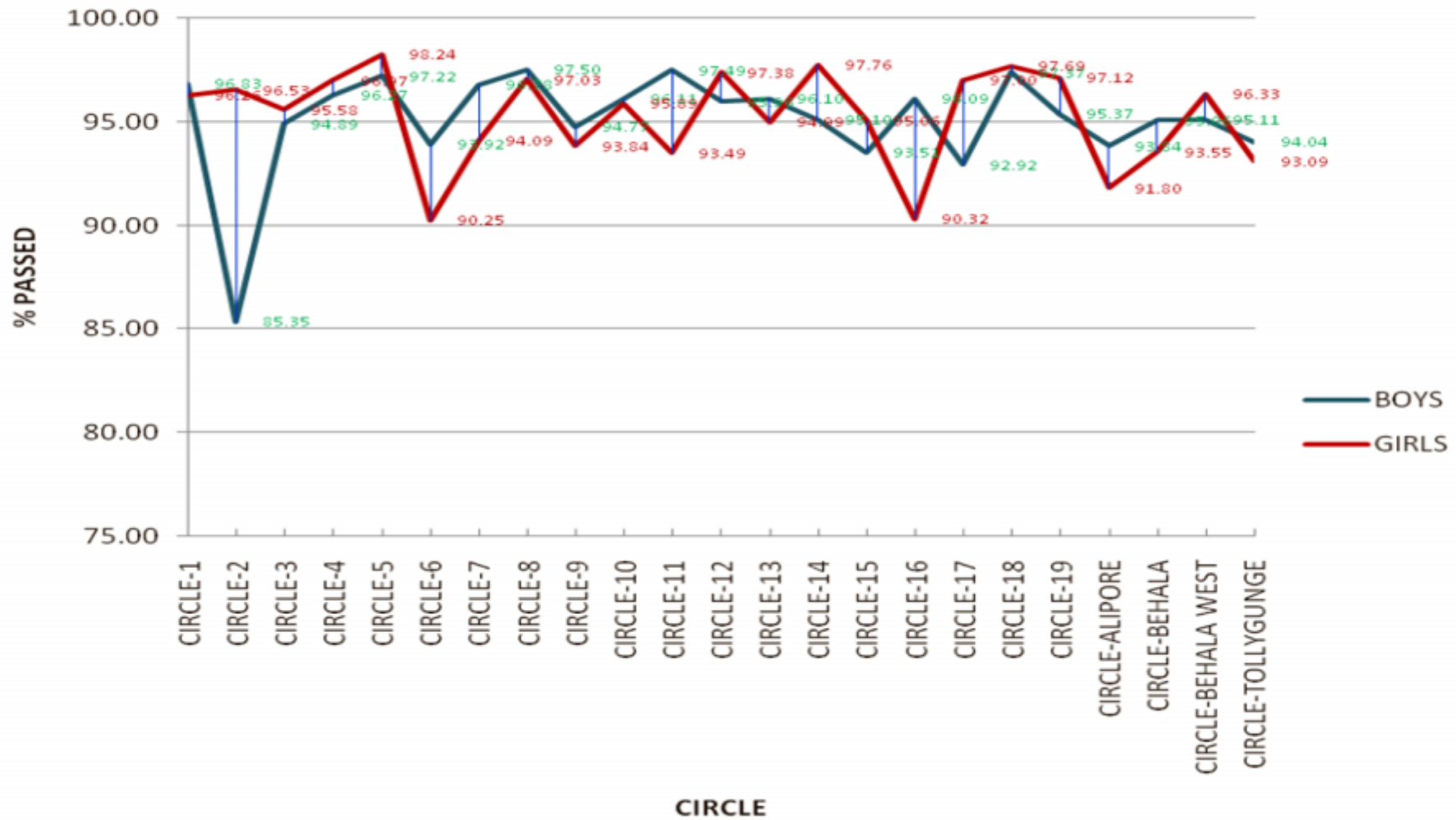

Primary- Class IV/V passed with > 60%

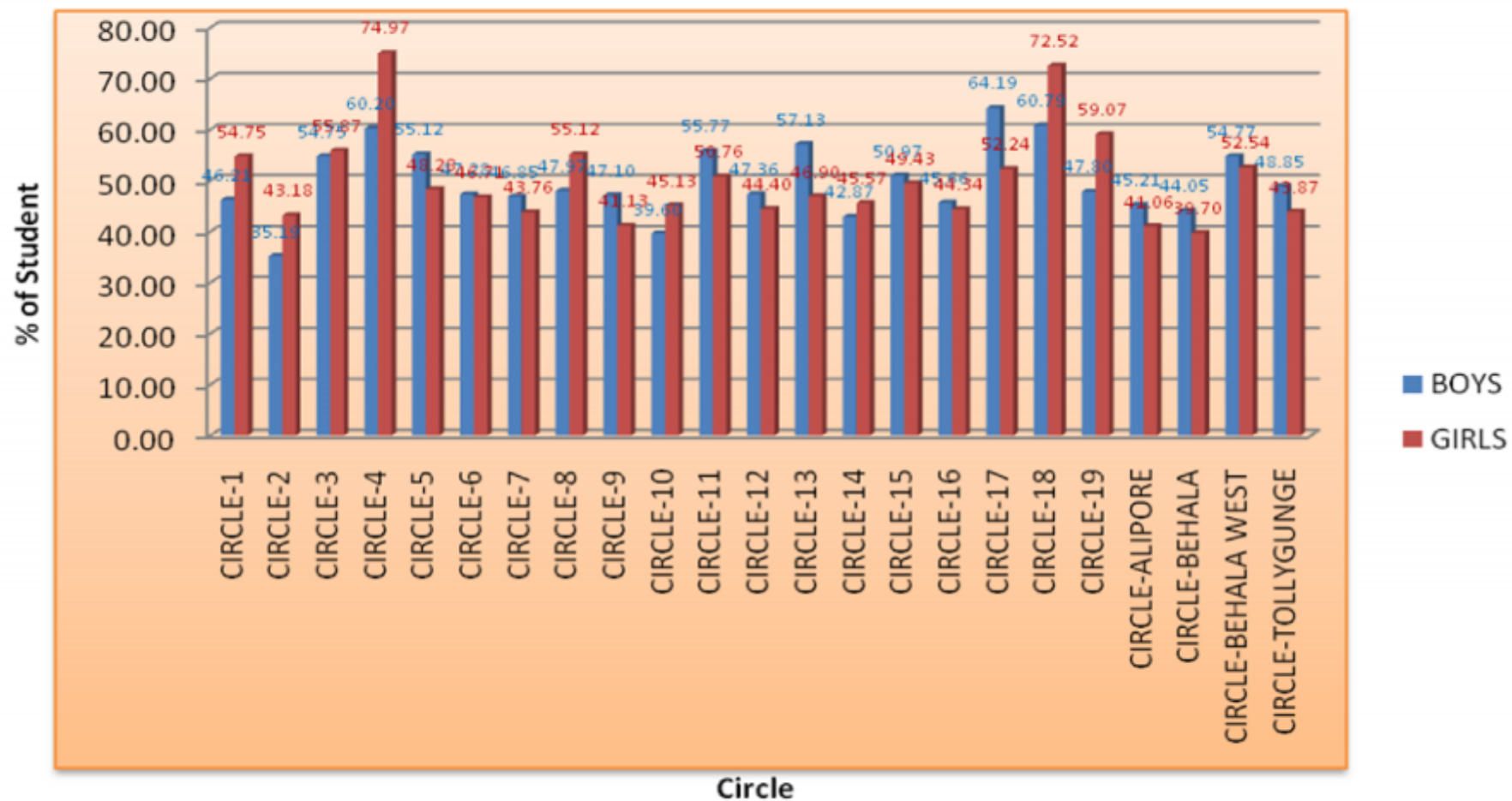

UPPER PRIMARY

RESULT ANALYSIS FROM DISE 2009-10 ALL MANAGEMENT										
CIRCLE	Class VIII									
	APPEARED		PASSED		PASSED WITH > 60%		% OF PASSED w.r to APPEARED		% OF PASSED WITH > 60% w.r to APPEARED	
	BOYS	GIRLS	BOYS	GIRLS	BOYS	GIRLS	BOYS	GIRLS	BOYS	GIRLS
CIRCLE-1	947	977	912	906	333	446	96.30	92.73	35.16	45.65
CIRCLE-2	809	774	745	704	117	234	92.09	90.96	14.46	30.23
CIRCLE-3	562	806	496	701	217	315	88.26	86.97	38.61	39.08
CIRCLE-4	730	598	658	577	411	475	90.14	96.49	56.30	79.43
CIRCLE-5	699	660	687	605	370	214	98.28	91.67	52.93	32.42
CIRCLE-6	1012	870	938	823	323	256	92.69	94.60	31.92	29.43
CIRCLE-7	1168	1663	1053	1518	386	544	90.15	91.28	33.05	32.71
CIRCLE-8	1557	1495	1504	1393	627	647	96.60	93.18	40.27	43.28
CIRCLE-9	1916	1793	1837	1737	956	754	95.88	96.88	49.90	42.05
CIRCLE-10	2075	1749	1960	1637	671	662	94.46	93.60	32.34	37.85
CIRCLE-11	2184	2532	2023	2376	1170	1219	92.63	93.84	53.57	48.14
CIRCLE-12	1304	1399	1227	1347	609	586	94.10	96.28	46.70	41.89
CIRCLE-13	626	734	610	660	316	212	97.44	89.92	50.48	28.88
CIRCLE-14	924	562	860	537	336	143	93.07	95.55	36.36	25.44
CIRCLE-15	876	449	798	409	393	183	91.10	91.09	44.86	40.76
CIRCLE-16	738	996	693	861	262	347	93.90	86.45	35.50	34.84
CIRCLE-17	881	1388	763	1334	358	527	86.61	96.11	40.64	37.97
CIRCLE-18	1695	1767	1646	1720	1066	1273	97.11	97.34	62.89	72.04
CIRCLE-19	691	420	654	391	243	167	94.65	93.10	35.17	39.76
CIRCLE-ALIPORE	1513	2240	1431	2111	529	675	94.58	94.24	34.96	30.13
CIRCLE-BEHALA	1699	1832	1569	1660	639	530	92.35	90.61	37.61	28.93
CIRCLE-BEHALA WEST	1270	1506	1236	1417	618	450	97.32	94.09	48.66	29.88
CIRCLE-TOLLYGUNGE	1318	1383	1249	1313	479	456	94.76	94.94	36.34	32.97
TOTAL	27194	28593	25549	26737	11429	11315	93.95	93.51	42.03	39.57

The graphical representation of the above table is as follows:-

Upper Primary- Class VIII - % of Passed pupil

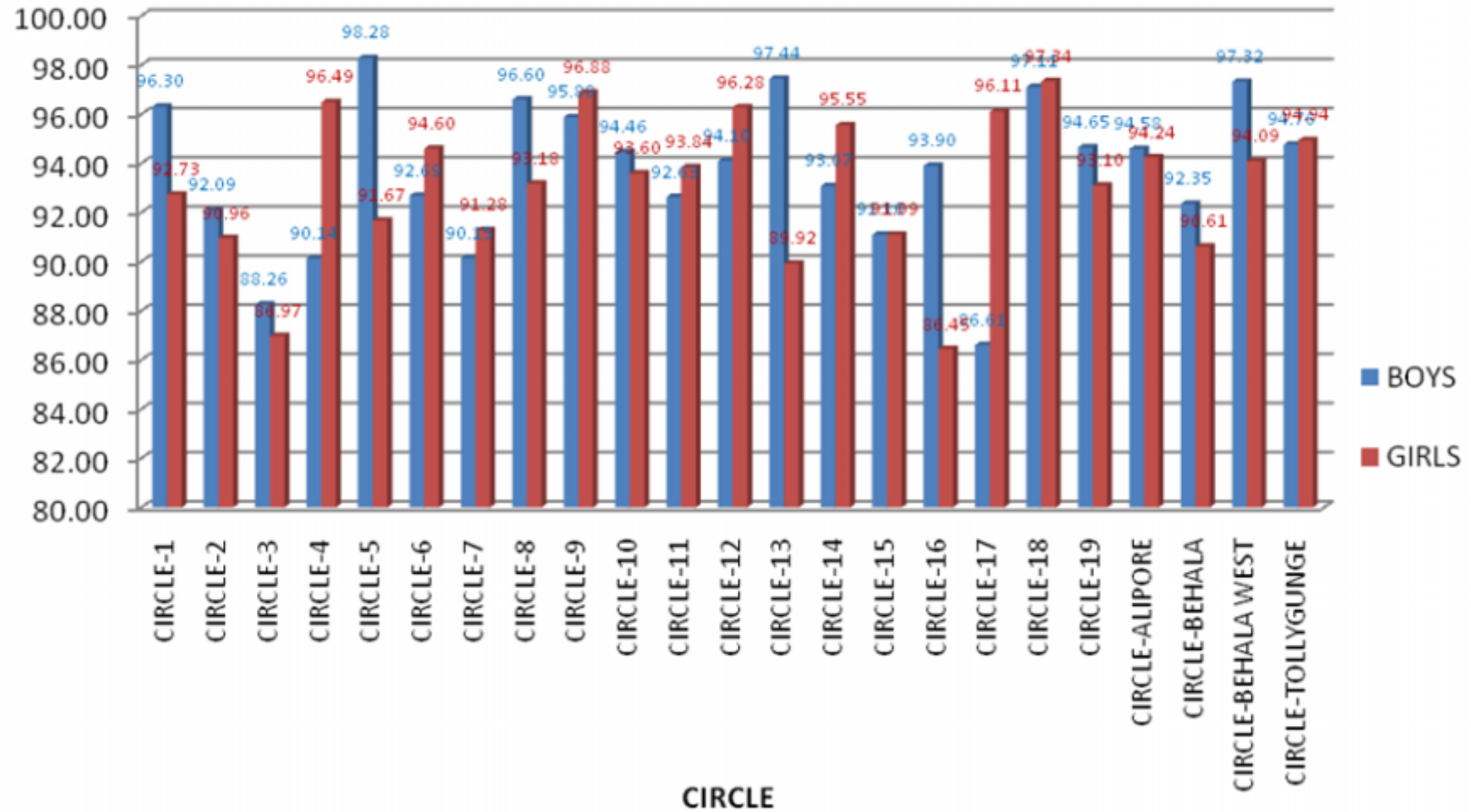

Upper Primary- Passed class VIII with >60%

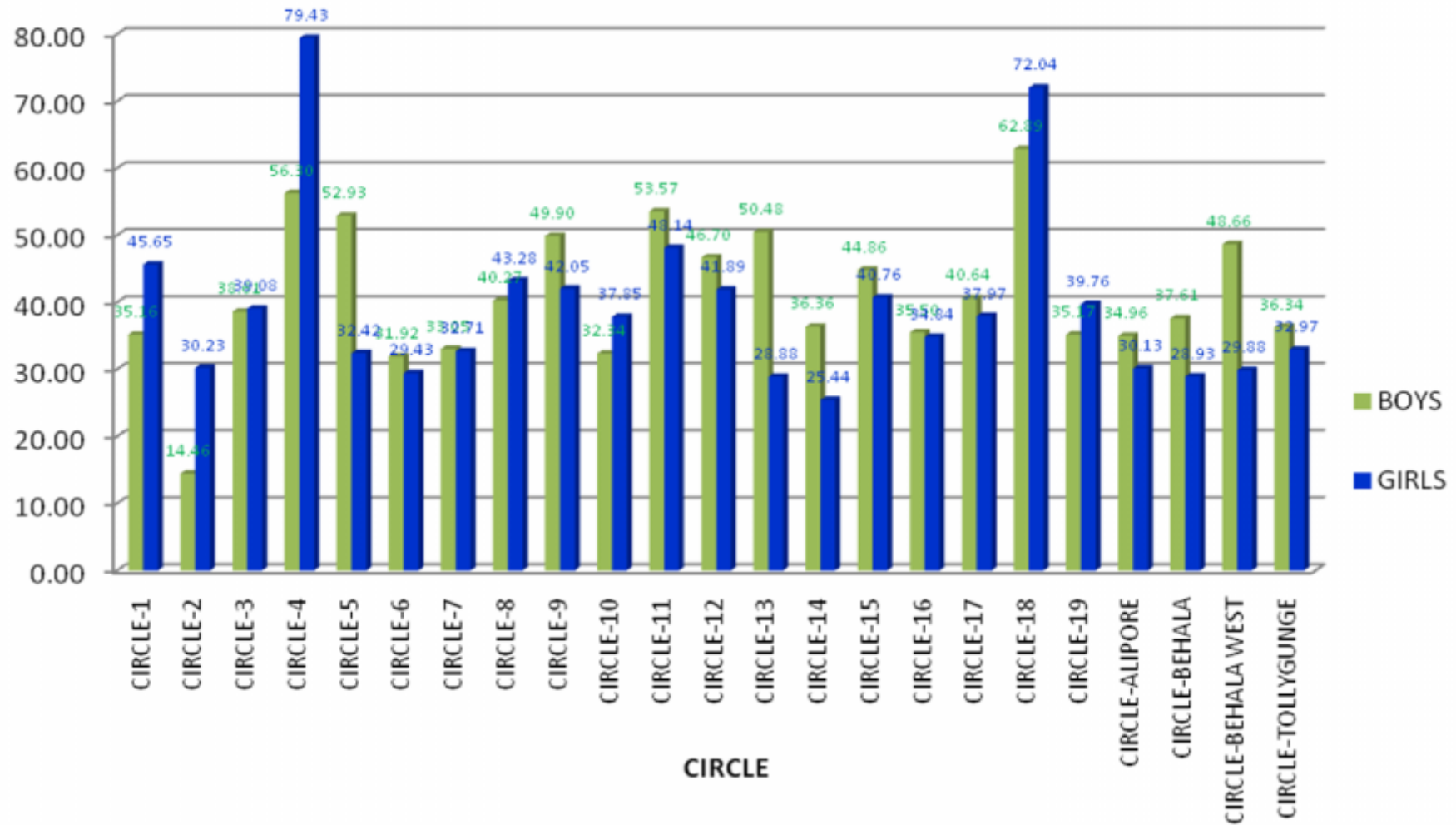

Circle wise Class wise Gender wise Repeater (I-IV)

All Management - from DISE-2009-10

CIRCLE	I		II		III		IV		Total
	Boys	Girls	Boys	Girls	Boys	Girls	Boys	Girls	
CIRCLE-1	57	46	22	25	25	17	24	26	242
CIRCLE-2	68	69	14	11	12	8	11	13	206
CIRCLE-3	25	34	10	8	12	11	9	6	115
CIRCLE-4	166	148	59	39	77	31	101	36	657
CIRCLE-5	65	71	25	21	18	25	16	32	273
CIRCLE-6	120	51	69	35	80	28	72	29	484
CIRCLE-7	221	99	170	77	185	114	167	111	1144
CIRCLE-8	73	44	52	35	29	22	34	15	304
CIRCLE-9	225	198	124	84	130	121	107	102	1091
CIRCLE-10	85	104	37	64	44	67	37	54	492
CIRCLE-11	53	83	27	30	25	39	17	52	326
CIRCLE-12	99	167	19	80	23	110	14	127	639
CIRCLE-13	69	71	37	32	29	28	27	24	317
CIRCLE-14	28	30	16	10	5	8	5	12	114
CIRCLE-15	124	110	36	26	21	29	27	28	401
CIRCLE-16	124	154	65	77	60	70	60	53	663
CIRCLE-17	111	107	61	93	67	82	89	114	724
CIRCLE-18	108	79	33	21	29	11	30	35	346
CIRCLE-19	118	74	72	19	57	12	56	15	423
CIRCLE-ALIPORE	373	254	209	161	166	115	205	117	1600
CIRCLE-BEHALA	92	74	49	49	33	40	40	36	413
CIRCLE-BEHALA WEST	104	71	73	68	91	66	78	63	614
CIRCLE-TOLLYGUNGE	258	253	192	161	166	186	144	167	1527
Total	2766	2391	1471	1226	1384	1240	1370	1267	13115

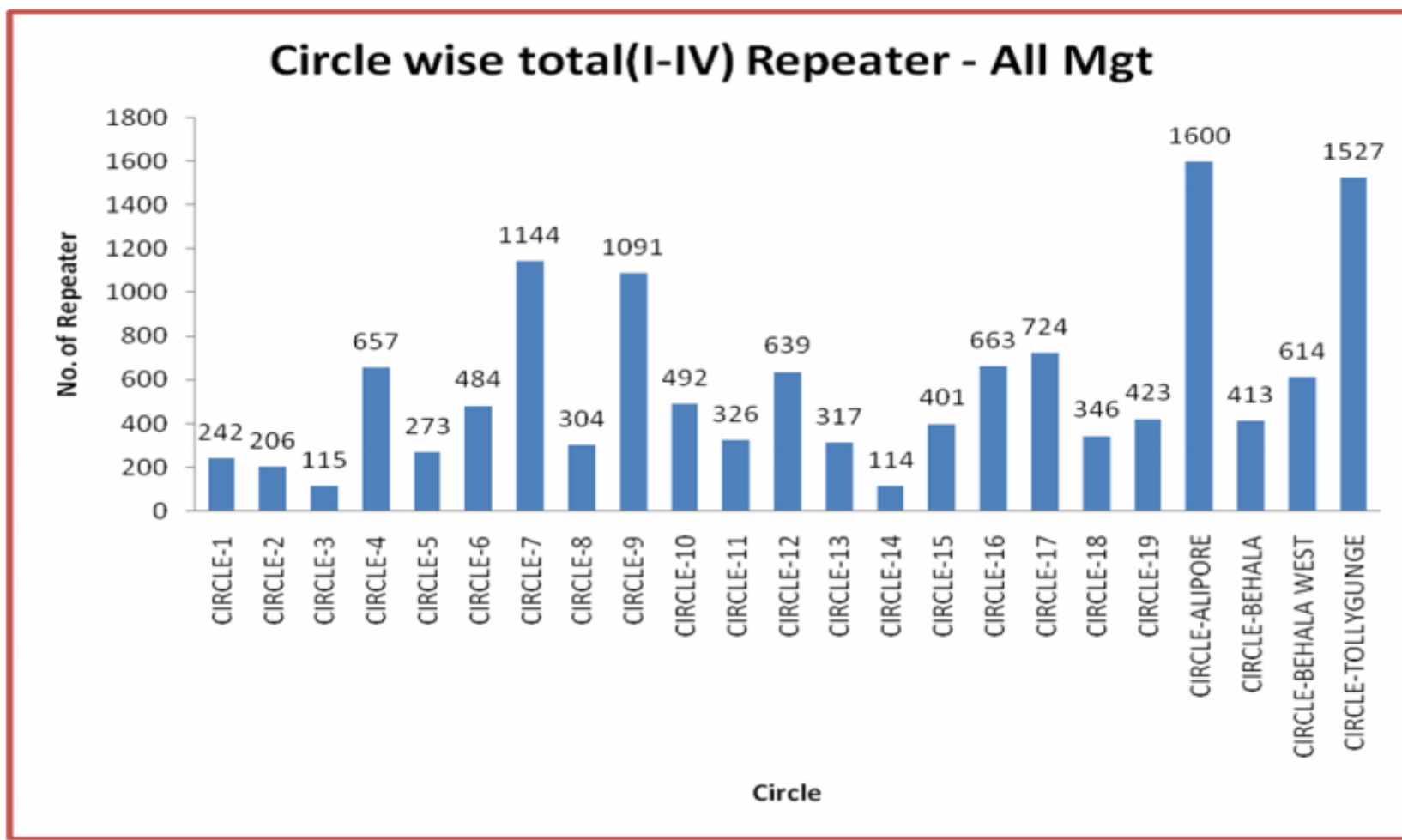

From the diagram of Circle wise total repeaters- Primary we get,

In Circles - 7, 9, Alipore, Tollygunge, repeater is high (very pick value w.r.to the mean) which implies very bad.

Nine (9) circles are above mean (570).

Four (4) circles are around mean, which implies the deviation is high.

However, the mean is high so overall District result is bad.

Circle wise Class wise Gender wise Repeater (V-VIII)

All Management - from DISE-2009-10

CIRCLE	V		VI		VII		VIII		Total
	Boys	Girls	Boys	Girls	Boys	Girls	Boys	Girls	
CIRCLE-1	36	63	21	26	41	39	16	47	289
CIRCLE-2	45	25	45	21	45	22	50	46	299
CIRCLE-3	45	19	53	26	66	49	77	42	377
CIRCLE-4	14	30	31	11	32	13	40	12	183
CIRCLE-5	13	27	18	16	25	48	13	29	189
CIRCLE-6	42	56	27	21	24	40	33	29	272
CIRCLE-7	125	133	58	53	98	72	110	76	725
CIRCLE-8	45	63	37	23	24	43	27	66	328
CIRCLE-9	79	231	37	151	52	158	43	130	881
CIRCLE-10	70	83	78	32	70	49	53	34	469
CIRCLE-11	90	52	92	52	118	74	127	69	674
CIRCLE-12	73	44	74	20	88	40	95	34	468
CIRCLE-13	22	48	17	23	28	42	40	46	266
CIRCLE-14	124	28	62	24	79	31	98	42	488
CIRCLE-15	133	37	52	28	46	24	63	36	419
CIRCLE-16	53	123	45	90	38	105	29	98	581
CIRCLE-17	61	61	38	45	45	71	53	48	422
CIRCLE-18	23	33	23	30	18	26	32	23	208
CIRCLE-19	17	10	4	7	11	6	8	12	75
CIRCLE-ALIPORE	309	399	121	148	66	120	48	76	1287
CIRCLE-BEHALA	122	169	102	136	64	152	80	153	978
CIRCLE-BEHALA WEST	55	42	46	33	58	97	40	32	403
CIRCLE-TOLLYGUNGE	51	89	59	66	70	108	53	90	586
Total	1647	1865	1140	1082	1206	1429	1228	1270	10867

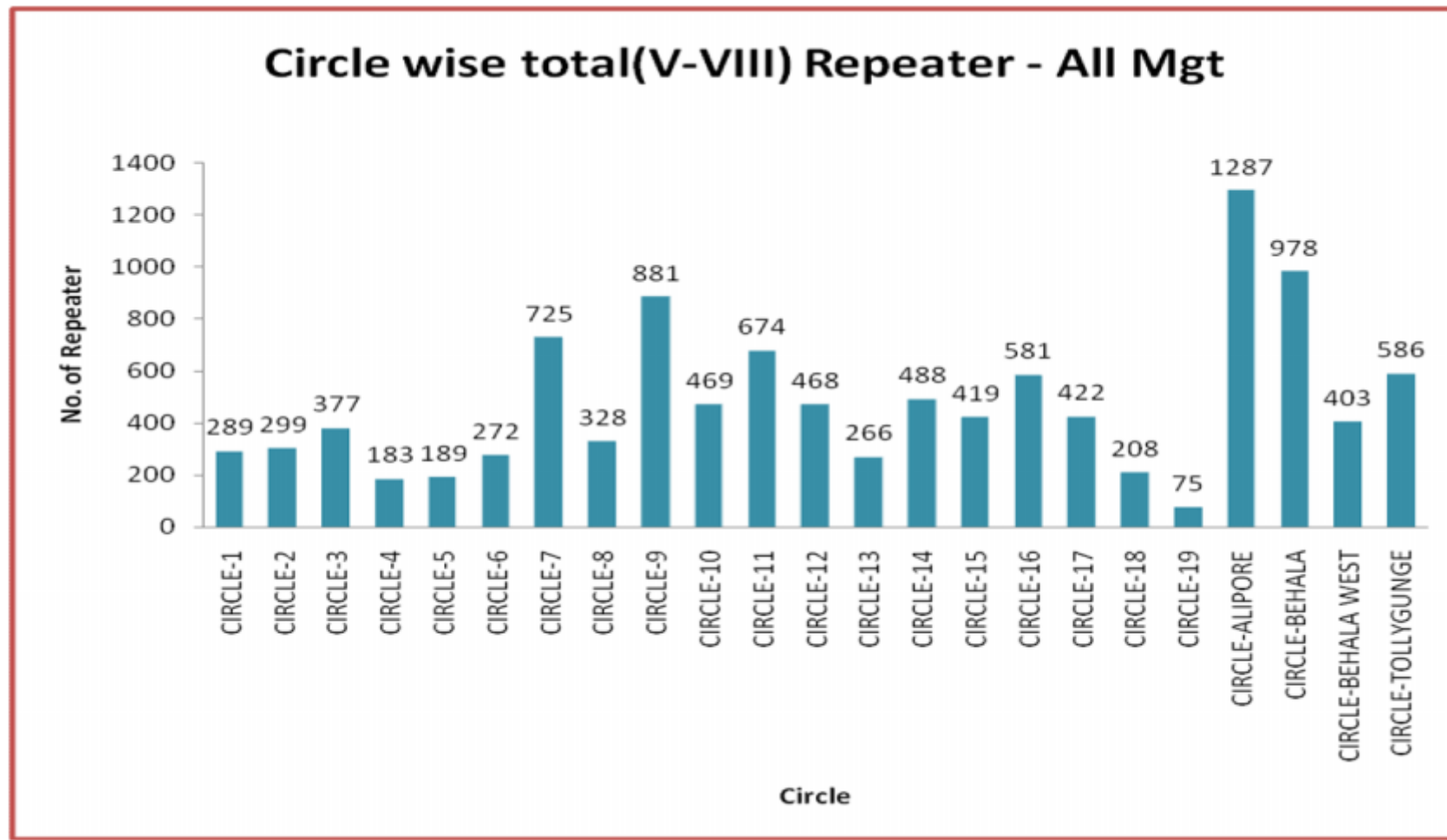

From the diagram of circle wise total repeater- U.Primary

Circle-7, 9, 11 Alipore, Behala, repeater is high

Eight (8) circles are above mean (472).

Four (4) circles are around mean, implies overall result is good

Circle –Alipore has very pick value (very bad), which ranked last in EDI ranking, so special focus zone is Circle-Alipore.

**KOLKATA MUNICIPAL
CORPORATION (KMC)
BOROUGH-WISE
ANALYSIS OF DISE 2009-10 DATA
(As on 30.09.09)**

BOROUGH-WISE ANALYSIS- PRIMARY

KMC BOROUGH	ESTIMATED POPULATION (5⁺-8⁺) (2009-10)	PRIMARY ENROLMENT (I-IV)	GER	% of SC ENROLMENT	% of ST ENROLMENT	% of MINORITY ENROLMENT
I	37481	17362	46	1.99	0.29	15.59
II	27257	9242	34	1.83	0.21	0.84
III	39395	18404	47	0.60	0.16	4.72
IV	33584	14995	45	1.33	0.04	1.60
V	30693	11834	39	2.76	0.38	18.61
VI	34861	13830	40	0.27	0.12	30.34
VII	59006	30180	51	5.08	0.25	26.61
VIII	33976	22862	67	2.01	0.45	3.36
IX	42154	23165	55	2.09	0.23	29.29
X	47054	22503	48	2.09	0.40	2.96
XI	23275	9011	39	4.04	0.23	2.72
XII	25707	12124	47	16.36	0.46	4.78
XIII	28623	9414	33	1.56	0.28	3.47
XIV	34080	16284	48	0.86	0.26	5.20
XV	32931	23897	73	1.89	0.04	52.79

BOROUGH-WISE GROSS ENROLMENT RATIO (GER) - PRIMARY

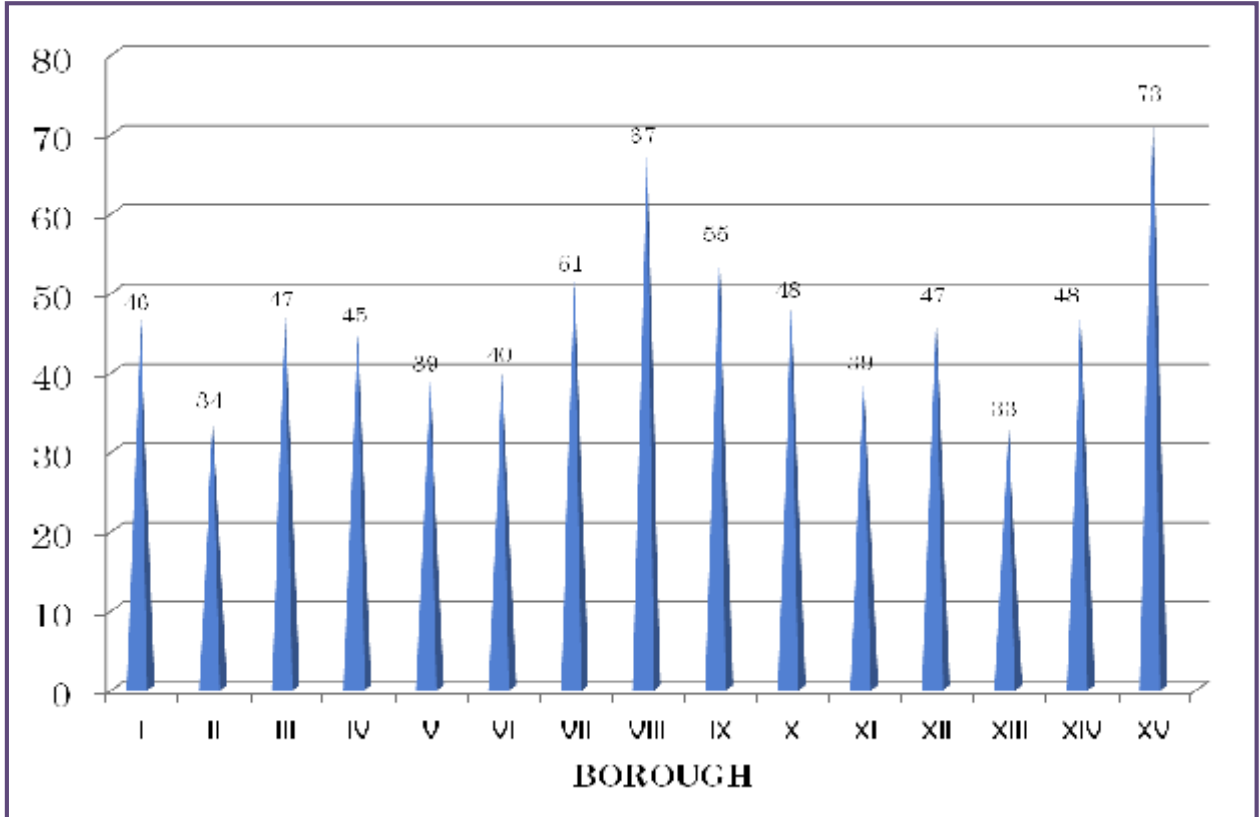

BOROUGH-WISE PERCENTAGE OF SC ENROLMENT - PRIMARY

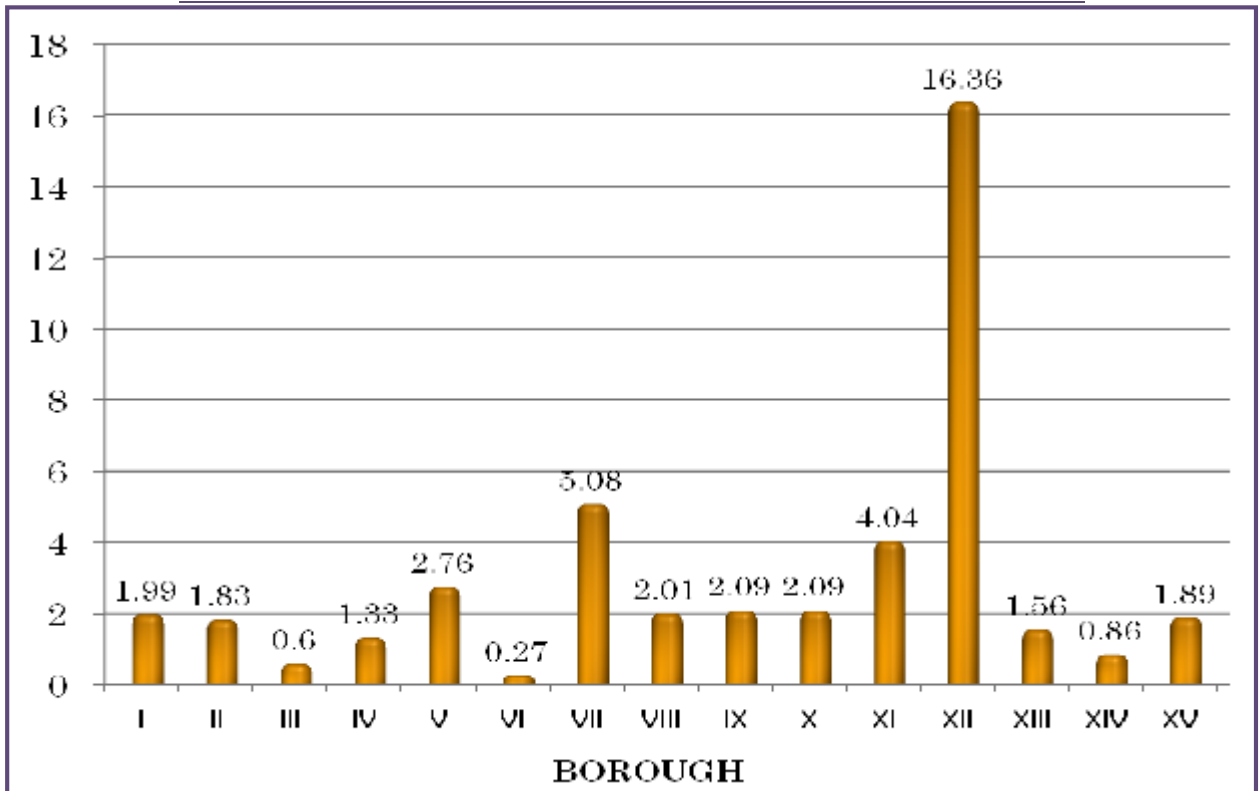

BOROUGH-WISE PERCENTAGE OF ST ENROLMENT - PRIMARY

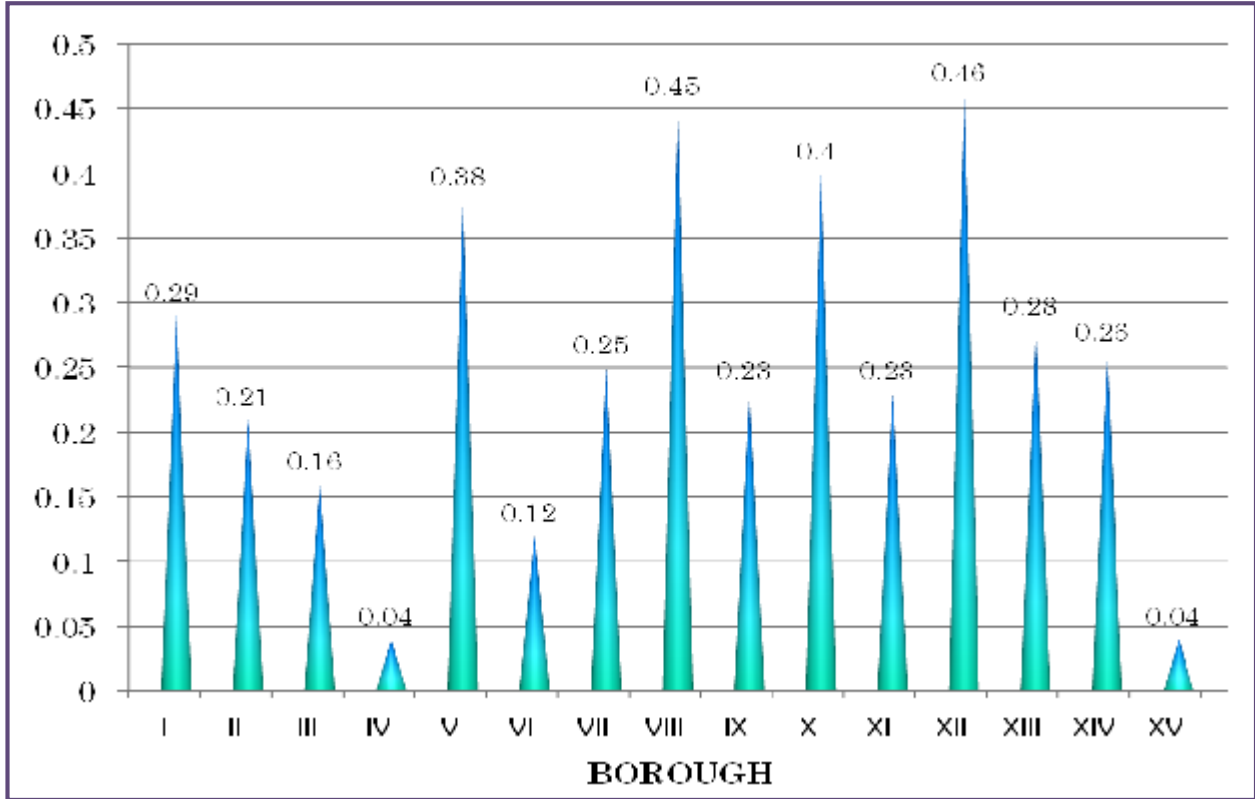

BOROUGH-WISE PERCENTAGE OF MINORITY ENROLMENT- PRIMARY

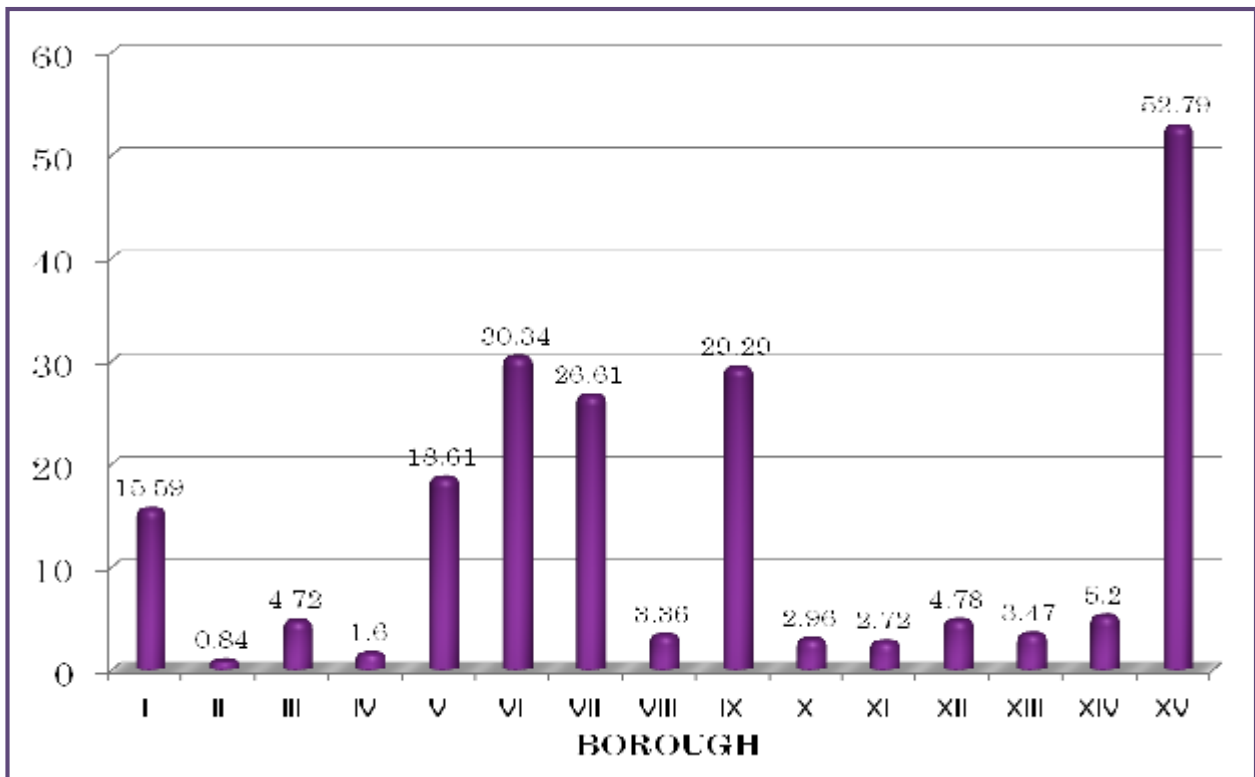

BOROUGH-WISE ANALYSIS- UPPER PRIMARY

KMC BOROUGH	ESTIMATED POPULATION (9⁺-13⁺) (2009-10)	UPPER PRIMARY ENROLMENT (V-VIII)	GER	% SC ENROLMENT	% ST ENROLMENT	% MIN ENROLMENT
I	30911	17029	55	6.33	0.66	12.07
II	22014	8669	39	4.14	0.45	0.60
III	32616	18365	56	10.63	0.40	1.24
IV	42238	13735	33	6.16	0.32	0.94
V	24297	13658	56	5.29	0.70	22.58
VI	29268	13477	46	3.20	0.29	42.31
VII	48866	20751	42	11.94	0.65	22.48
VIII	27555	23191	84	5.90	0.53	3.09
IX	34656	21082	61	6.76	0.59	29.57
X	38850	27839	72	10.72	0.82	2.73
XI	19025	6422	34	24.73	0.64	2.94
XII	21143	8668	41	44.36	0.74	0.93
XIII	23282	11620	50	10.22	0.47	4.97
XIV	28063	13527	48	18.01	0.46	5.40
XV	26824	21013	78	4.82	0.22	60.85

BOROUGH-WISE GROSS ENROLMENT RATIO (GER) - UPPER PRIMARY

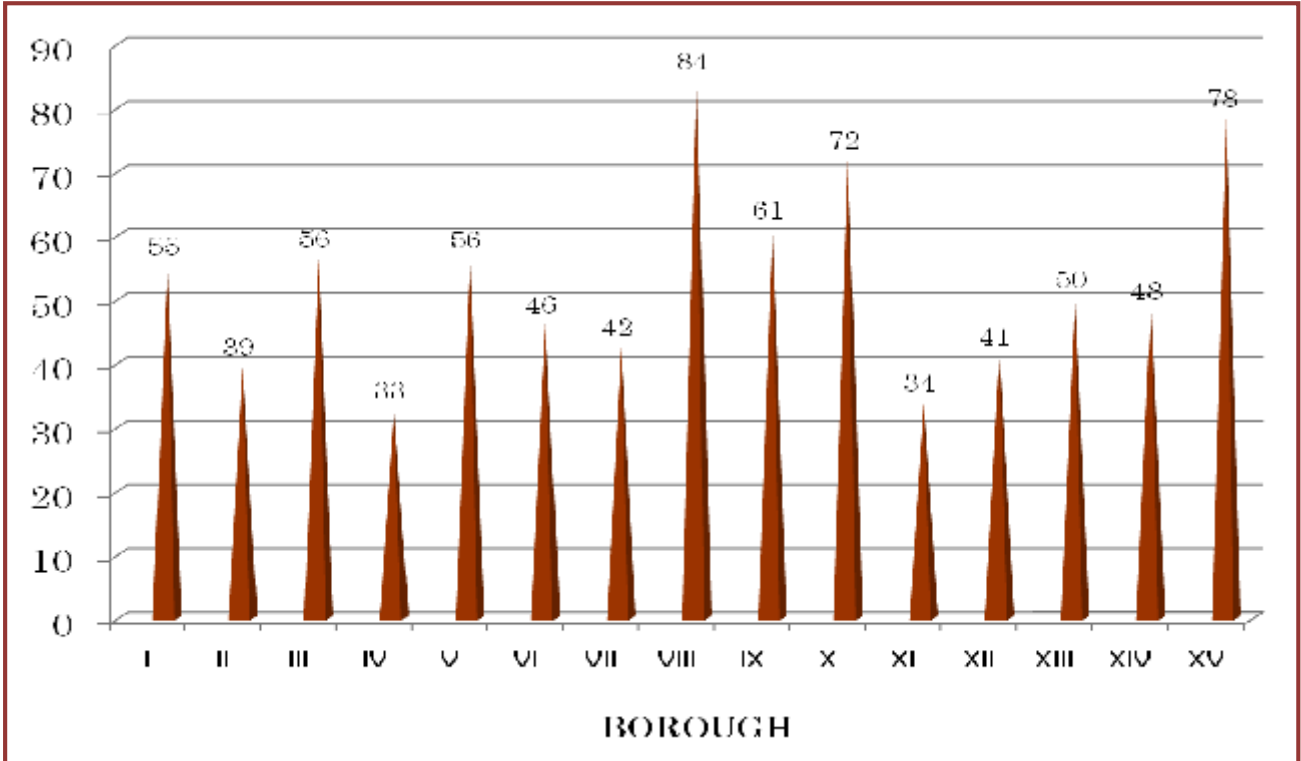

BOROUGH-WISE PERCENTAGE OF SC ENROLMENT - UPPER PRIMARY

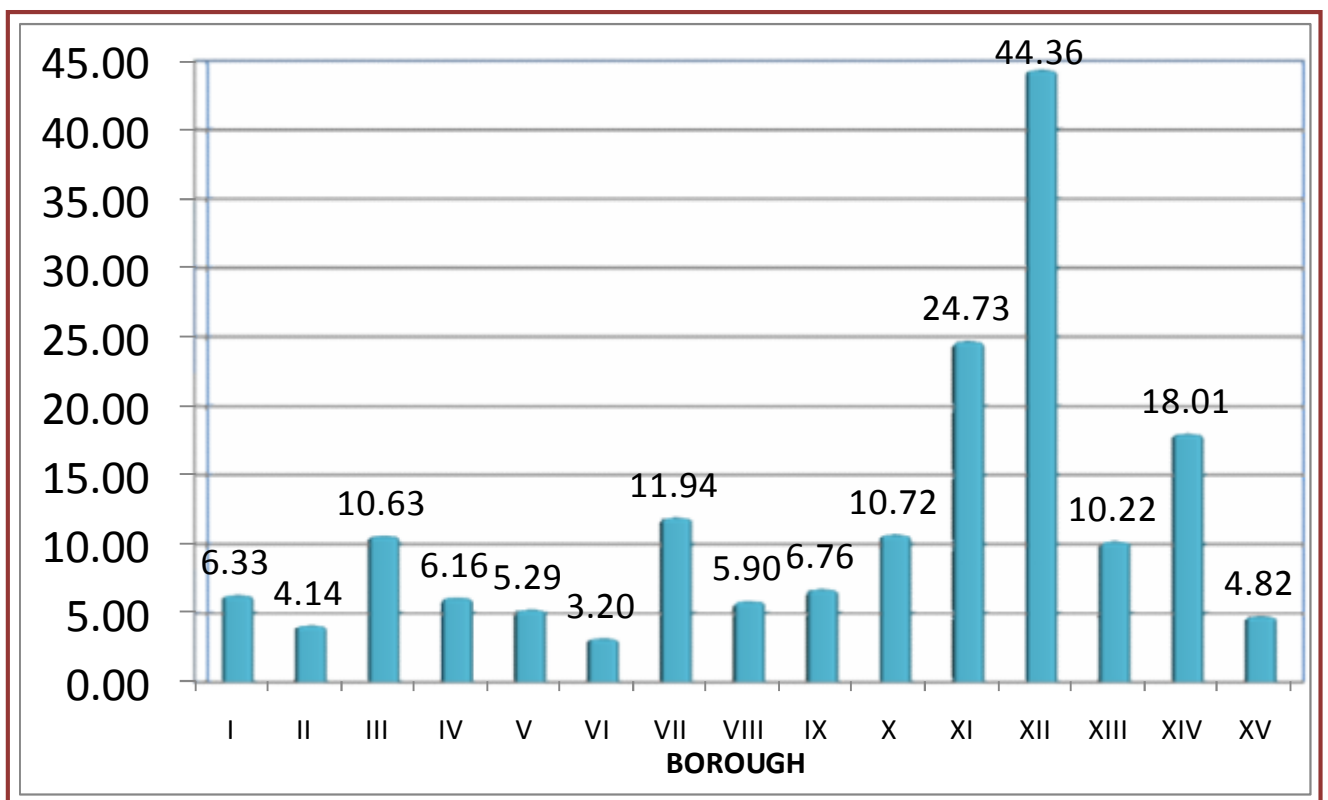

BOROUGH-WISE PERCENTAGE OF ST ENROLMENT - UPPER PRIMARY

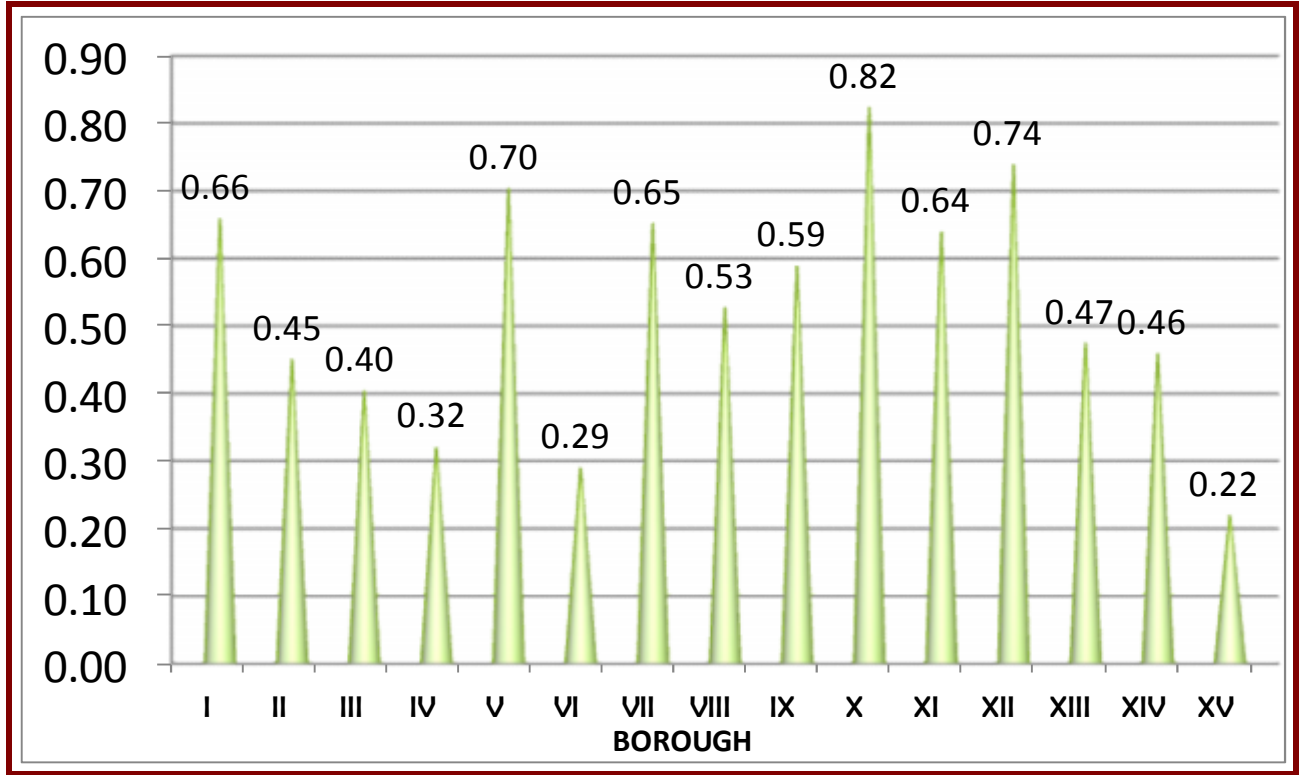

BOROUGH-WISE PERCENTAGE OF MINORITY ENROLMENT- UPPER PRIMARY

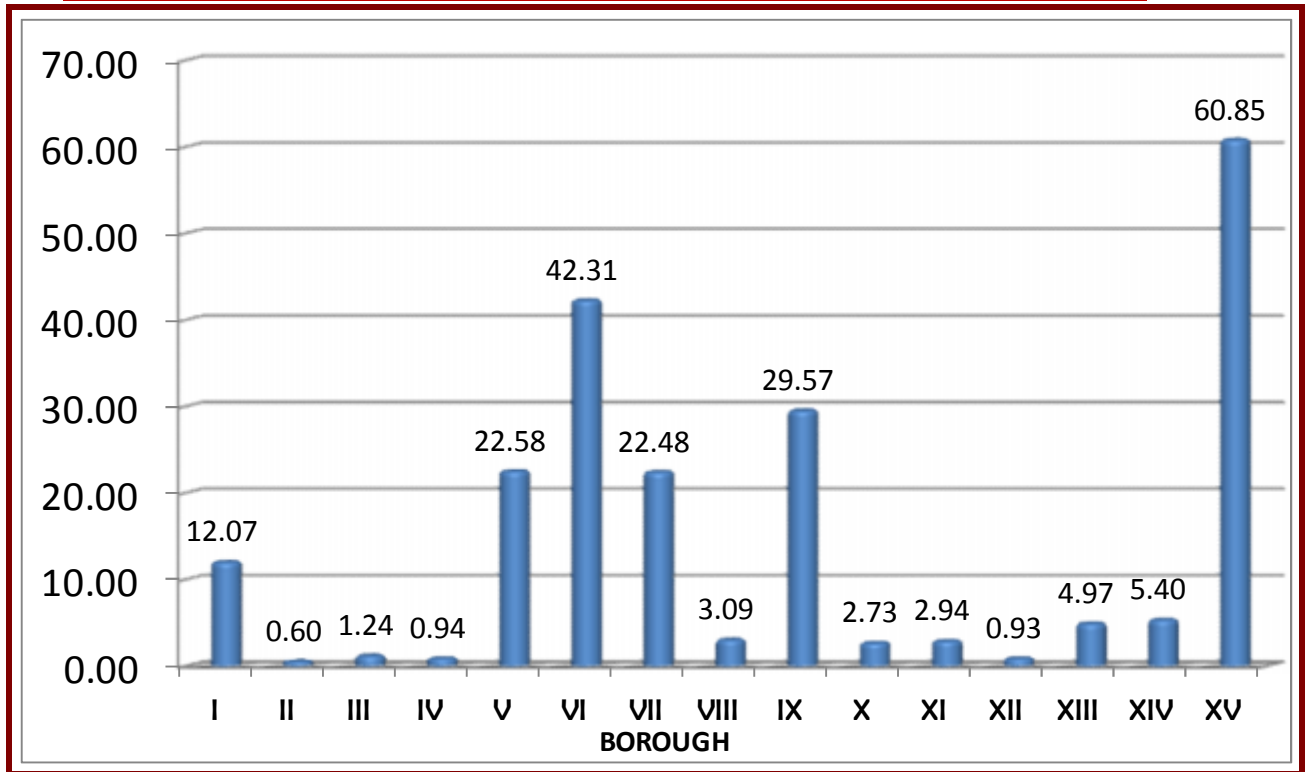

BOROUGH-WISE GENDER PARITY INDEX (GPI) - PRIMARY

KMC Borough	Enrolment			GPI
	Boys	Girls	Total	
I	8817	8545	17362	96.92
II	4268	4974	9242	116.54
III	9525	8879	18404	93.22
IV	6340	8655	14995	136.51
V	6711	5123	11834	76.34
VI	6882	6948	13830	100.96
VII	14111	16069	30180	113.88
VIII	10441	12421	22862	118.96
IX	11877	11288	23165	95.04
X	12033	10470	22503	87.01
XI	4621	4390	9011	95.00
XII	6184	5940	12124	96.05
XIII	4735	4679	9414	98.82
XIV	7861	8423	16284	107.15
XV	11615	12282	23897	105.74

BOROUGH-WISE GENDER PARITY INDEX (GPI) - PRIMARY

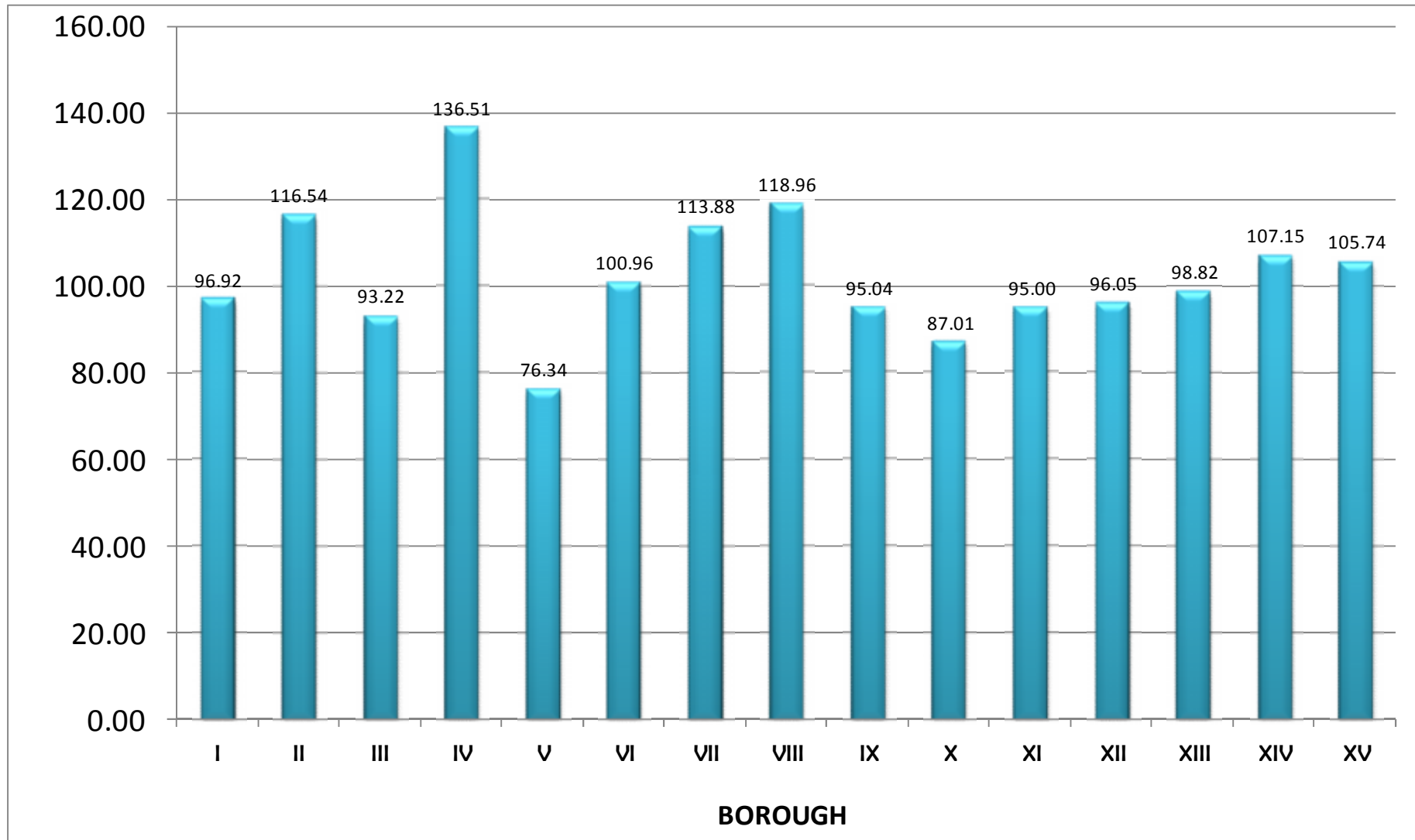

BOROUGH-WISE GENDER PARITY INDEX (GPI)-UPPER PRIMARY

KMC Borough	Enrolment			GPI
	Boys	Girls	Total	
I	8731	8298	17029	95.04
II	4913	3756	8669	76.45
III	9318	9047	18365	97.09
IV	5959	7776	13735	130.49
V	7389	6269	13658	84.84
VI	5869	7608	13477	129.63
VII	8760	11991	20751	136.88
VIII	11236	11955	23191	106.40
IX	10936	10146	21082	92.78
X	13815	14024	27839	101.51
XI	2861	3561	6422	124.47
XII	3935	4733	8668	120.28
XIII	5515	6104	11619	110.68
XIV	6234	7293	13527	116.99
XV	9047	11966	21013	132.26

BOROUGH-WISE GENDER PARITY INDEX (GPI) - UPPER PRIMARY

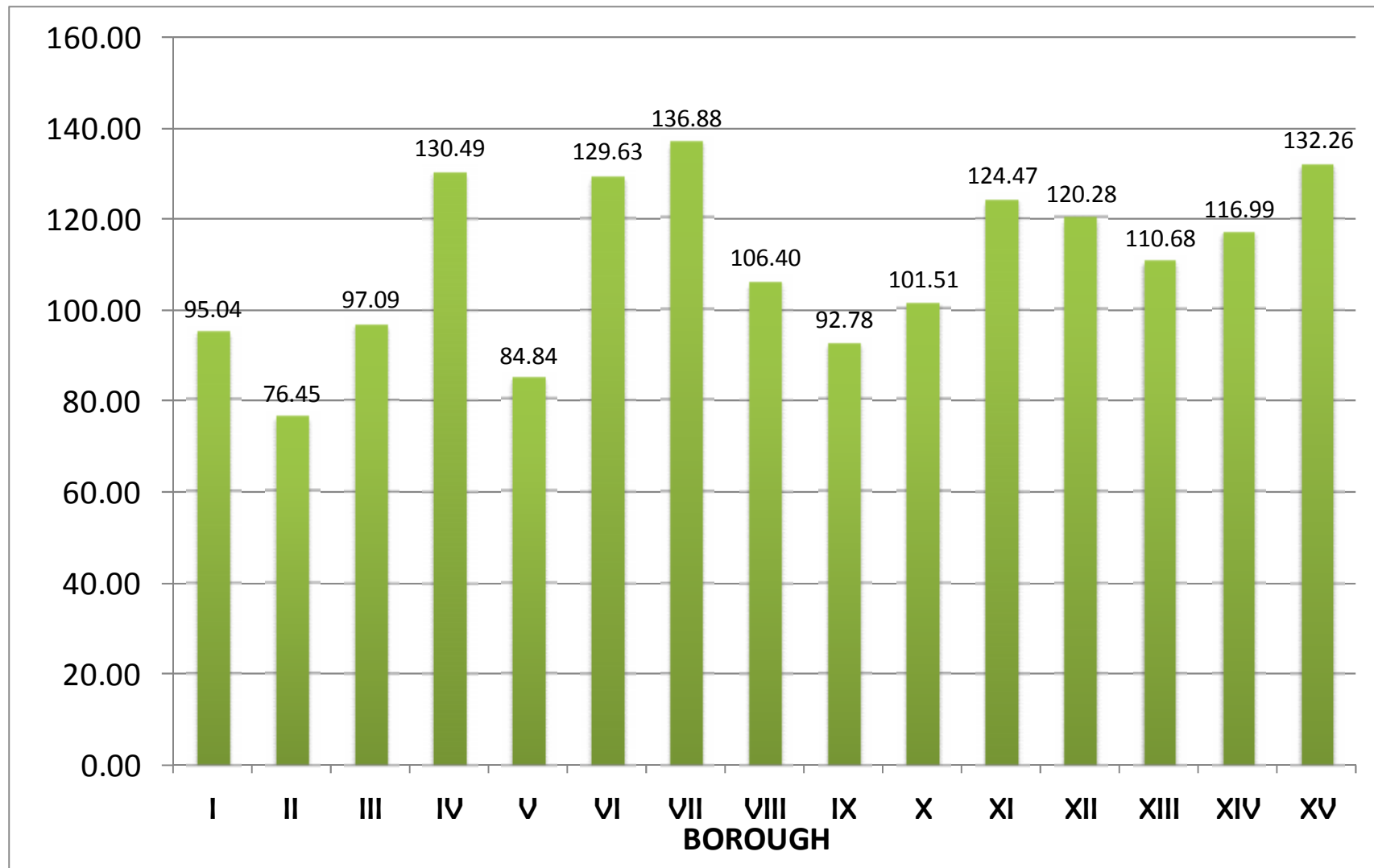

MANAGEMENT INFORMATION SYSTEM (MIS)

Background:

Management Information System (MIS) is basically intended to collect, analyze, extract, retrieve and integrate data from various sources in order to supply necessary information for managerial decision.

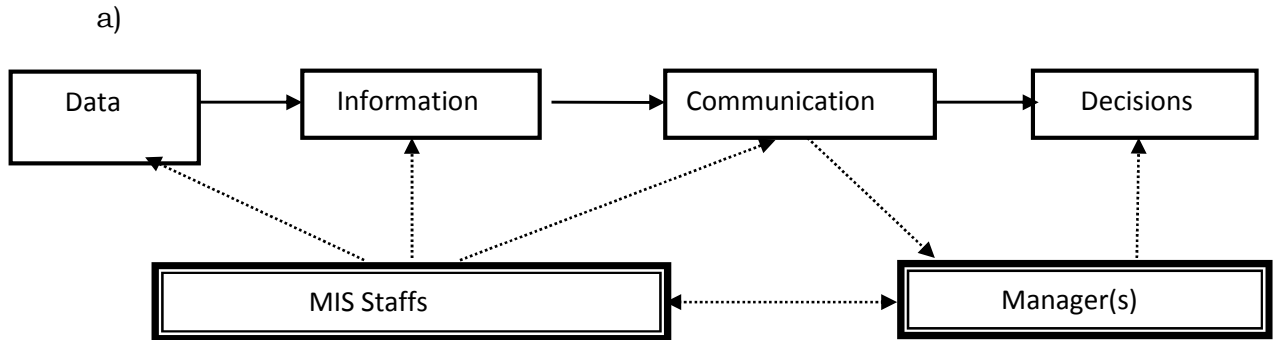

Fig 1: Logical Entity of MIS.

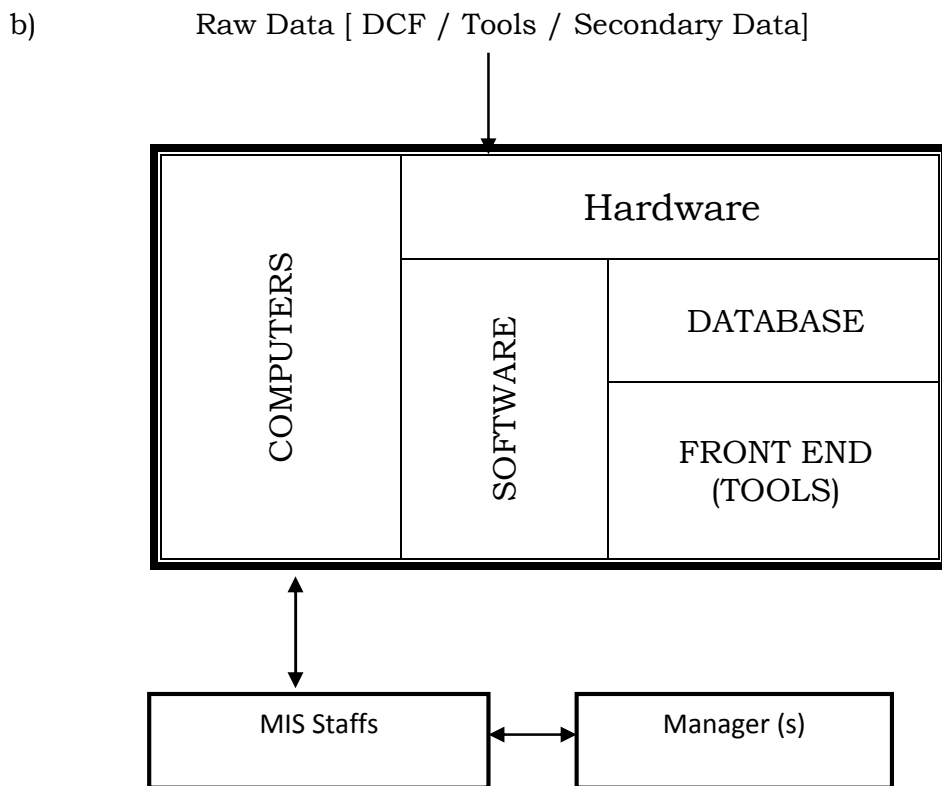

Fig 2: Physical Entity of MIS.

Computers are important for more quantitative than qualitative approach. It has some special features like speed, accuracy and storage of large amount of data.

In view of above, for better functions following goals have been set:

- a. Effective and efficient management.
- b. Planning process to be driven by database.
- c. Decision making process with the use of information base.
- d. Multi-directional flow and sharing data and information base at all levels (District, Circle, CRC and School).

MIS provides several benefits to the organization: the means of effective and efficient coordination between Departments; quick and reliable referencing; access to relevant data and documents; improvement in organizational and departmental techniques; day-to-day assistance in a Department and closer contact with the rest of the world.

Objectives

- To create comprehensive database at primary education level at the district level and review the status every year.
- Improvement of MIS activity to an extent so that it can act as Decision Support System (DSS).
- To evaluate monitor enrolment and retention.
- Evaluating and monitoring of pupils' achievement with special emphasis on girl's education, education of deprived section, minorities.
- To ensure the informative approach for the implementation of all programme.
- Publishing reports and data through National Web portal of SSA.
- Finally to achieve the target of SSM.

Relationships between EMIS and PMIS under MIS:

As the SSA is itself an Educational project PMIS may be consider as a subset of EMIS. On the other hand, SSA programme is a project then EMIS may be consider as a subset of PMIS. So the model depicted below may be accepted.

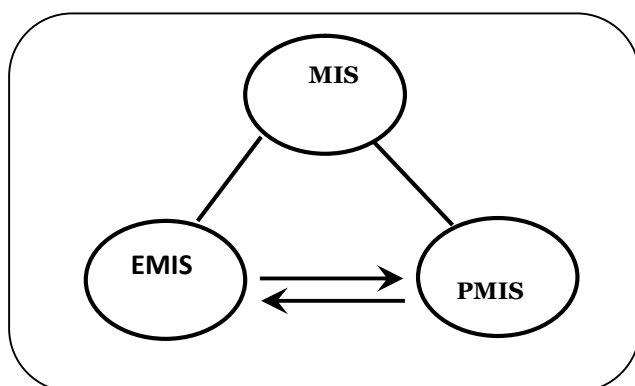

Tree structure

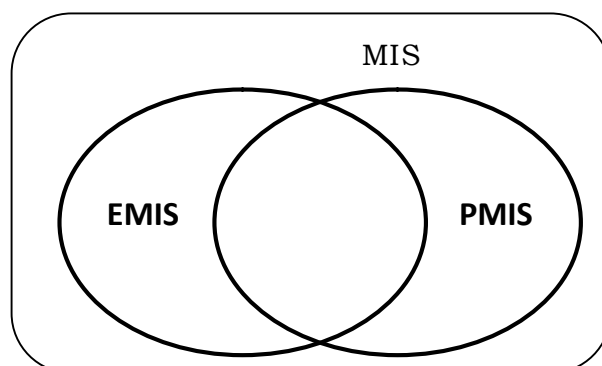

Venn Diagram

DISE in Educational Management Information System(EMIS):

Management Information System (MIS) plays a pivotal role in every organization by acquiring, storing and retrieving necessary and relevant information from database to place before Managers for their necessary plans.

There are three components of Management Information System (MIS)

1. General User.
2. Database Administrator / System Analyst/MIS-In-Charge.
3. Computer and Peripherals.

In the last component (computer and peripherals), there must be some dedicated tools /softwares for collecting, storing and querying data. For Example, District Information System for Education (DISE) is one of the coherent tools in implementing Educational Management Information System (EMIS) in Sarva Shiksha Mission, Kolkata.

PMIS (Project Management Information System):

In Management Information System(MIS), Sarva Shiksha Mission there exist PMIS, which is running very well along with EMIS with the following activities:

1. Enterprise Resource Planning(ERP) has been implemented(Tally ERP 9.0 is going on with full swing by keeping all financial component of SSM).
2. Spreadsheet management technique has been used for other type of PMIS activity.
3. Finally National Web Portal, may be considered as a part of E-Governance System has also been implemented.

MIS through DISE (Data collection method and etc.)

Three parts of DISE have been taken into consideration for DISE programmes every year.

1. Data collection through DISE Data Capture Format (DCF) from every school as on 30th September each year.
2. Consistency checking which is followed by Data Entry to DISE database through a Graphic User Interfaced Front End, that is designed keeping in view the DCF.

3. Consistency checking which is succeeded by regular reporting from the software to the administrator for planning and monitoring the education system.

About DISE Software:

DISE-District Information System for Education, a very well tuned database and the front end software, developed by National Institute for Educational Planning and Administration (NIEPA) in collaboration with UNICEF.

The software is running in the Client-Server architecture where the database is a worldwide and well known efficient ORACLE database.

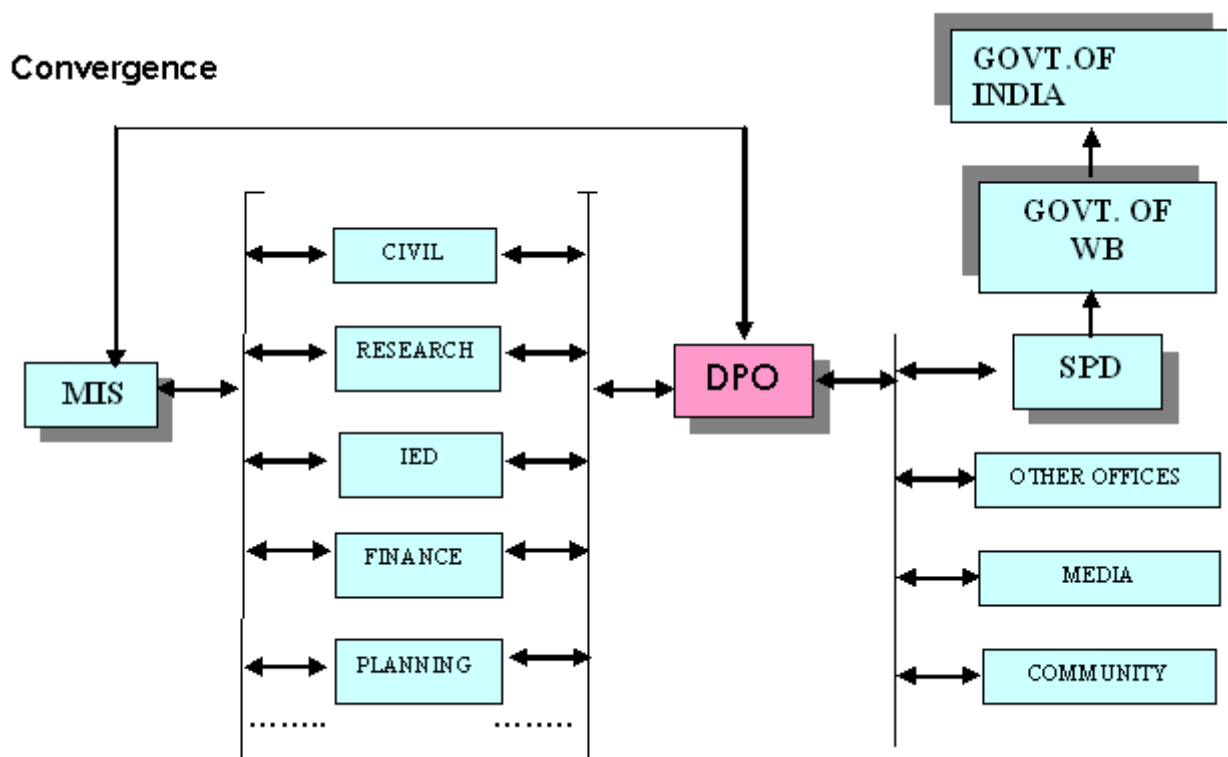

Progress overview

Management Information System(MIS) is going on with high performance with the following activities at the District level in Sarva Shiksha Mission, Kolkata.

1. Creation and maintenance of database (DISE) keeping records below.
 - Infrastructure of the school.
 - Student Enrolment Record.
 - Regarding Incentives of students.
 - Teacher Record.
 - Examination Result.
 - No of Children with Disabilities.
 - Ward Information.
 - Etc.
2. Creation and maintenance of database (COHORT,CWSN, EBBBAS &etc).
3. Created software to monitor civil grant and other grant (PMIS activity).
4. Created software For Child tracking(CWSN children).
5. Updating databases.
6. Reporting & supplying information frequently.
7. Spreadsheet making (mainly for PMIS activity).
8. EDI data analysis and Circle level EDI ranking Journal published on 29.07.09 based on DISE data.
9. GIS has been Introduced.
- 10.Documentation of various activities.
- 11.Cover page/Vignette design of various Journals/study material/teaching material published by SSM, Kolkata.
- 12.Data collection process is going on for Private schools
- 13.Website Development.

Future activities:

Some sub-system of Management Information System will be proposed to set up at the District level and the following programme will be taken up.

1. Creation of record of Total children in the age group 5+ to 13+.
2. Creation of records of Name-wise particulars of enrolled children and out-of-school children.

3. Creation of database of students belonging to Minority Community.
4. Updating of National Web Portal of SSA.
5. Maintenance of database like IED, SCK, DISE & etc.
6. Pupil achievement in various school subjects.
7. Enrolment, retention and completion rate.
8. Progress in different activities.
9. Optimization of Information Acquisition Process.
10. Pay-Roll, stock control (EOQ model) may be included under PMIS activity.
11. Reducing anomalies of data (checking consistency).
12. To aware the necessity/importance of EMIS (MIS/Information Technology) to School/Community people and other people attached with SSM, Kolkata by taking different activity (e.g., conducting seminar etc.).
13. Decentralized Database, i.e., URC level Data Bank Creation.
14. Full implementation of GIS.

Challenges

1. To collect Information from all schools (all categories and management) in Kolkata. Viz.,
 - Govt. schools.
 - Govt. Aided Schools
 - Private aided schools
 - Kendriya Vidyalaya
 - DA getting schools
 - Christian missionary Schools
 - Private unaided schools
 - ICSE & CBSE schools etc.
2. Introduce child census software to create database of all children in Kolkata.
3. Data entry to monitor civil works and other grant.
4. Create software to monitor Project Management activities.
5. To setup a database system at URC and CRC level for proper monitoring.

Infrastructure required for implementation of successful MIS:-

- Computer Laboratory Environment.
- Provision of computers and peripherals.
- Training of MIS staffs.
 - SQL Statement Tuning training of MIS-In-Charge and PMIS Coordinator.
 - GIS training of MIS-In-Charge and PMIS Coordinator.
 - Accounting Package Training of PMIS Coordinator and DEO.
- Motivation.
- Typing activity should be separated from the MIS-Cell to support the importance of MIS reporting.

Computer Aided Learning (CAL)

Definitions:

Computer Aided Learning (CAL) or Computer Assisted learning can be defined as learning or teaching subjects like mathematics, Science, Geography, and etc., through computers with subject wise learning packages/materials.

- It may include all types of [Technology-Enhanced Learning](#) (TEL), where technology is used to support the learning process.
- It is said to be: "[Pedagogy](#) empowered by digital technology".
- In broader sense, it may be considered as a part of [E-Learning](#).

History of Computer-based Learning

Computer assisted learning, or CAL, is not a new phenomenon. Computer Assisted Learning can be defined as a computer program or file developed specifically for educational purposes. The technique used throughout the world in a variety of contexts, from Primary school to University. In the 1980s, the first computer assisted learning became available to University students. The CAL Idea is highly dependent to the following educational events:

- Education Commission (1964-66), called Kothari Commission: Introduction of Vocational Courses.
- National Policy of Education(1968): Introduction of Correspondence Courses.
- Edger Dale: Cone of Learning, Cone of Experience(Audio-Visual Methods in Teaching, 3rd ed., New York, 1969).
- Jacques Delors: The Four Pillars of Education,1996(Learning to be, Learning to Do, Learning to Know, Learning to Live Together).

Implementation:

It was felt that use of Information and communication Technology (ICT), computers and developed e-teaching/learning materials in the form of CAL may help in achieving the objectives stated below. Keeping this in view, CAL, a

component of computer Education has been running under 'Innovation' since 2005-06 under the supervision of SSM, Kolkata.

Main Objectives:

- These visual, animated learning materials not only help to memorize the tough topics at ease but also it will act as a virtual laboratory experiments.
- Some so called hard subjects, viz., English, Mathematics and Science will be joyful through computer.
- Computer aided learning packages will serve as a better teaching learning materials.
- This audiovisual technique will help and motivate Children With Special Needs (CWSN) to read.
- Above objectives will in turn help to reduce drop out, repetition rate. Enhance in the achievement levels etc.,.

SSM believes, under this programme all pupil will accept it enthusiastically and all educational aspirants will appreciate this.

Implementation technique:

A computer room (laboratory room is must) with some computers along with an audio and visual output device to show learning packages on a large screen using an LCD projector. After discussion of subject, teacher may show learning packages on that particular topic. Student can practice and also an evaluation can take place like E-Exam (as it is also on computer and at the same time result can be displayed to the students).

Infrastructural Components:

- 1) Laboratory Room.
- 2) Computers and LCD Projector.
- 3) Learning Packages.
- 4) Trained Teachers.
- 5) Motivation.
- 6) Discipline, Administration etc.

Achievement:

As per DISE data analysis of the previous year CAL schools (Financial years: 2005-06, 2006-07, 2007-08 and 2008-09), following conclusion reveals.

Item	Conclusion
Enrolment(Before CAL , After CAL)	Enrolment Increased after CAL
Number Passed (Before CAL , After CAL)	Increased after CAL(Quality improved)
Got First Class((Before CAL , After CAL)	Increased after CAL(Quality improved)
Reference: Handout on Analysis of Educational Development Index, A Journal Published by SSM, Kolkata on 29.07.09 based on DISE data.	

Two Case Studies:-

Case study 1:

Hypothesis: “Enrolment will increase after implementation of CAL”

Alternative Hypothesis: “Enrolment will decrease or remain steady after implementation of CAL”

Sample: 32 U.P schools under CAL programme 2008-09.

Data Source: Enrolment of 32 CAL schools from DISE, before
Implementation of CAL Programme (Year: 2009-09) and
after implementation of CAL Programme(Year: 2009-10).

Result:

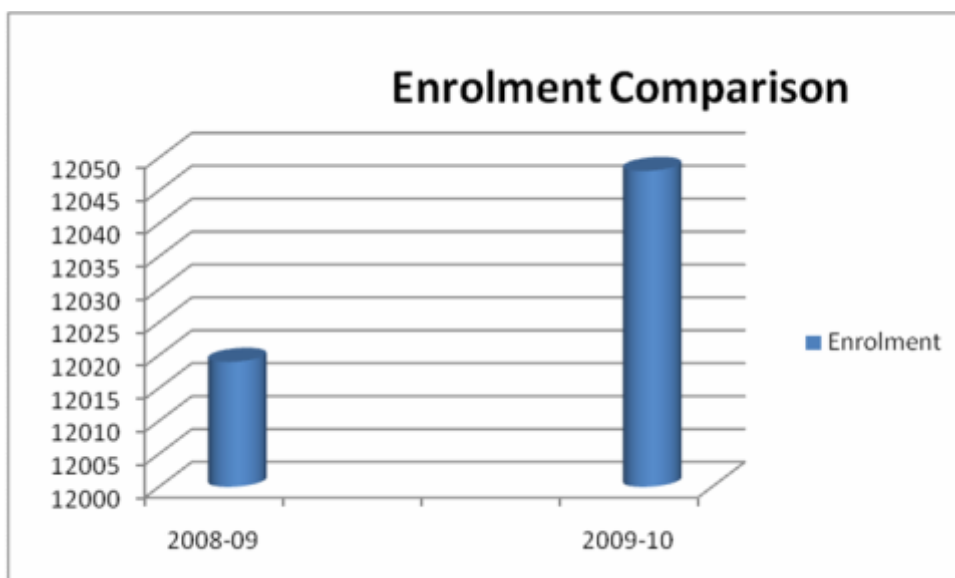

Conclusion: From the result, it reveals that the enrolment increased from 12019 to 12048 in 32 selected CAL U.P. Schools. Hence our Hypothesis “Enrolment will increase after implementation of CAL” is justified.

Case study 2:

Hypothesis: “Average Daily Attendance will improve after implementation of CAL”

Alternative Hypothesis: “Enrolment will decrease or remain steady after implementation of CAL”

Sample: 32 U.P schools under CAL programme 2008-09.

Data Source: Enrolment of 32 CAL schools from DISE for two consecutive years, Year 2008-09 and 2009-10.

Result:

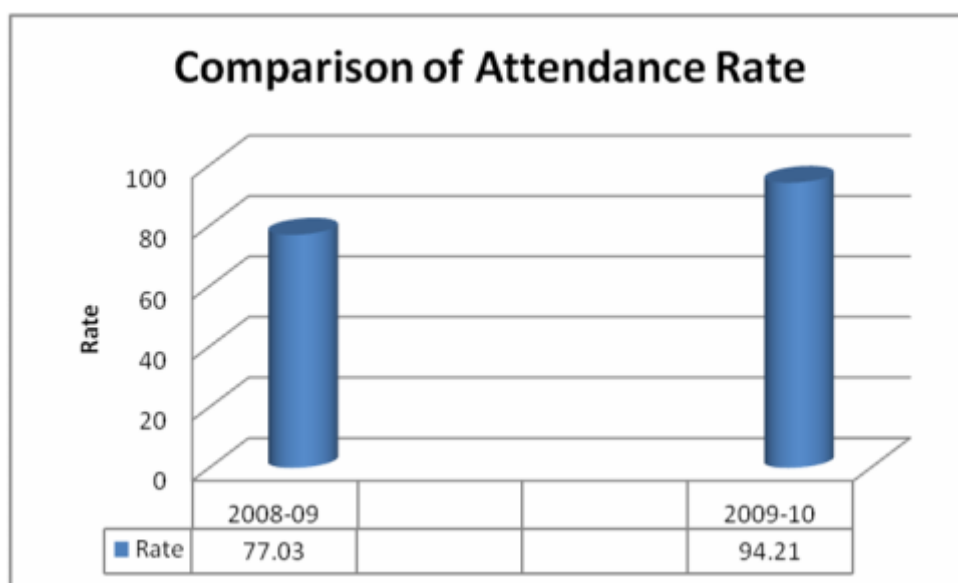

Conclusion: From the result, it reveals that the Average Daily Attendance (Student of Class V-VIII) from 77.03% to 94.21% in 32 selected CAL U.P. Schools. Hence, our Hypothesis “Average Daily Attendance will improve after implementation of CAL” is justified.

Wards under Circle at Kolkata

Circle	KMC-Ward(s)
I	2,3,4,5
II	1,6,7,
III	10,11,17,18
IV	21,22,23,25,42
V	12,13,15,16,28
VI	26,39,41,43,44
VII	27,29,30,33,34,35
VIII	37,38,40,45,46,47,48,49,50,51,52,53
IX	54,59,60,61,62,64,65,66
X	75,76,77,78,79,80
XI	63,70,71,72,73,84,85,86,87
XII	89,90,93,94,97,114
XIII	96,99,100,110
XIV	95,98,103,113
XV	14,31,32,
XVI	36,55,56,57,58
XVII	67,68,69,91,92,107
XVIII	74,81,82,83,88
XIX	8,9,19,20,24
TOLLYGUNGE	101,102,103,104,105,106,108,109,111,112
BEHALA	115,116,117,118,119,120,121,122,123,124
BEHALA (W)	125,126,127,128,129,130,131
ALIPORE	132,133,134,135,136,137,138,139,140,141

Wards under Kolkata Municipal Corporation (KMC)
Borough as on 30th September 2009:-

Borough	KMC-Ward(s)
I	1, 2, 3, 4, 5, 6, 7, 8, 9
II	10, 11, 12, 15, 16, 17, 18, 19, 20
III	13, 14, 29, 30, 31, 32, 33, 34, 35
IV	21, 22, 23, 24, 25, 26, 27, 28, 38, 39
V	36, 37, 40, 41, 42, 43, 44, 45, 48, 49, 50
VI	46, 47, 51, 52, 53, 54, 55, 60, 61, 62
VII	56, 57, 58, 59, 63, 64, 65, 66, 67
VIII	68, 69, 70, 71, 72, 73, 84, 85, 86, 87, 90
IX	74, 75, 76, 77, 78, 79, 80, 82, 83, 88
X	81, 89, 91, 92, 93, 94, 95, 96, 97, 98, 99, 100
XI	101, 102, 110, 111, 112, 113, 114
XII	103, 104, 105, 106, 107, 108, 109
XIII	115, 116, 117, 118, 119, 120, 121, 122, 123
XIV	124, 125, 126, 127, 128, 129, 130, 131, 132
XV	133, 134, 135, 136, 137, 138, 139, 140, 141

Note: - The DISE data analysis is based on data as on 30.09.2009. So the Borough analysis is based on the above table. The new Wards under Borough list is as follows.

Wards under Kolkata Municipal Corporation (KMC) Borough (latest):-

Borough	KMC-Ward(s)
I	1, 2, 3, 4, 5, 6, 7, 8, 9
II	10, 11, 12, 15, 16, 17, 18, 19, 20
III	13, 14, 29, 30, 31, 32, 33, 34, 35
IV	21, 22, 23, 24, 25, 26, 27, 28, 38, 39
V	36, 37, 40, 41, 42, 43, 44, 45, 48, 49, 50
VI	46, 47, 51, 52, 53, 54, 55, 60, 61, 62
VII	56, 57, 58, 59, 63, 64, 65, 66, 67
VIII	68, 69, 70, 72, 83, 84, 85, 86, 87, 88, 90
IX	71, 73, 74, 75, 76, 77, 78, 79, 80, 82
X	81, 89, 91, 92, 93, 94, 95, 96, 97, 98, 99, 100
XI	103, 104, 110, 111, 112, 113, 114
XII	101, 102, 105, 106, 107, 108, 109
XIII	115, 116, 117, 118, 119, 120, 122, 123, 124
XIV	121, 125, 126, 127, 128, 129, 130, 131, 132
XV	133, 134, 135, 136, 137, 138, 139, 140, 141

Addendum:

Note of some chart and tables are not been written because they are self-explanatory and there may plenty of options to analyze, research. This office as well as educationists may extend their own techniques/tools for further analysis of each and every table.

Erratum:

There may be slight difference (0% to 0.2%) among District total, Circle wise total and Borough wise total because of the insufficient (missing data) and some acceptable statistical reasons for this kind of heterogeneous (combination of OLTP and Data Warehouse) large Database, but it is confirmed that this kind of variance will not affect planning as well as research activities.

References:

1. Educational Development Index (EDI) by Dr. Arun C. Mehta and Mr. Shamshad A. Siddiqui, Dept. of EMIS, NUEPA, New Delhi.
2. www.education.nic.in
3. www.dise.in
4. Statistical Methods by N.G. Das

Development Team:

Joydev Dubey
Kushal Purakayastha
Monojit Dey
Satarupa Guha Thakurta (Coordinator)
Supratim Chakraborty (Team leader)
Swapan Pramanik



চিত্ত যেথা ভয়শূন্য, উচ্চ যেথা শির,
জ্ঞান যেথা মুক্ত, যেথা গৃহের পাটীর
আপন প্রাক্গতলে দিবসশবরী
বসুধারে রাখে নাই খন্ড ক্ষুদ্র করি,
যেথা বাক্য হৃদয়ের উৎসমুখ হতে
উচ্ছসিয়া উঠে,যেথা নির্বারিত স্রোতে
দেশে দেশে দিশে দিশে কর্মধারা ধায়
অজয় সহস্রবিধ চরিতার্থতায়--
যেথা তুচ্ছ আচারের মরুবালুরাশি
বিচারের স্রোতঃপথ ফেলে নাই গ্রাসি,
পৌরুষেরে করে নি শতধা; নিত্য যেথা
তুমি সর্ব কর্ম চিন্তা আনন্দের নেতা --
নিজ হস্তে নির্দয় আঘাত করি, পিতঃ,
ভারতেরে সেই স্বর্গে করো জাগরিত।

----গুরুদেবের সার্থ জন্মশতবর্ষে, সর্বশিক্ষা মিশনের বিনম্র প্রণাম।

Knowledge is of two kinds; we know a subject ourselves, or we know where we can find information upon it.

- Samuel Johnson

Sarva Shiksha Abhiyan is not only a programme for Universal Elementary Education (UEE), but also a Commitment and Mission



SARVA SHIKSHA MISSION, KOLKATA

"SHIKSHA BHAWAN"

27A, Bosepukur Road, (Kasba) Kolkata -700 042 (2nd Floor), E-Mail: ssmko_dp@sfy.com

Web site: <http://ssmkolkata.tripod.com>